



Whac-A-Mole pro Operation Manual

WARNING

Be sure to read this Operation Manual before using your machine to ensure safe operation.

©2011 Bob’s Space Racers Incorporated

427 15th Street, Daytona Beach, Florida 32117

Tel: (386) 677-0761 Fax: (386) 677-0794

TABLE OF CONTENTS:

(for online viewers press “Ctrl+Home” at anytime to return to this page)

MODEL VIEW	2	INSTALLATION	7	Mole Head Shaft Cleaning....	15
SPECIFICATIONS	3	Play zone (Operation Zone):..	7	Procedure 1 Instructions.....	15
Power Supply Rating:.....	3	Locations to avoid:.....	7	Procedure 2 Instructions.....	16
Power consumption:.....	3	Game Leveling:.....	8	Procedure 3 Instructions.....	17
Dimensions:.....	3	CONNECTING THE POWER		TROUBLESHOOTING	21
Weight:.....	3	CORD	9	Trouble-Shooting Chart	22
INTRODUCTION	4	INSTRUCTION FOR PLAY ..	10	ELECTRONIC /	
Overview:	4	OPTION SETTINGS	11	ELECTRICAL REPAIR	23
FEATURES:	4	Credit, Credit Time, Scores per		Power Supply Replacement .	23
<i>New Solenoid Operation</i>	4	Ticket.....	11	PCB Board Replacement	23
<i>Cabinet Design</i>	4	Points for Hit, Mercy Ticket..	12	Score Sensor Replacement..	24
<i>Electronics</i>	4	Mole Speed, Attract, Music,		Solenoid Replacement	24
<i>Programming</i>	4	Bonus Ticket	13	PARTS LIST	25
<i>Self Diagnostics</i>	4	Bonus +, Max Bonus, Bonus		WARRANTY	29
<i>Game Play</i>	4	Score to Win	13	WHEN CALLING FOR	
GAME SET-UP, OPERATION		MAINTENANCE AND		SERVICE	30
AND MAINTENANCE	5	INSPECTION	14		
Important Safety Information..	5	Maintenance	14		
Set Up	5	Cleaning	14		
PACKAGE CONTENTS	6	COIL BED SERVICING	15		

www.bobsspacracers.com

May 2011

MODEL VIEW

Whac-A-Mole pro



SPECIFICATIONS

Power Supply Rating:

110VAC ±5%, 60 Hz.

(Note: As for the actual voltage, please refer to the label on the game).

Power consumption:

Minimum 660W (6 Amps)

Dimensions:

32" W x 28" D x 84 1/4" H

Weight:

243 lbs

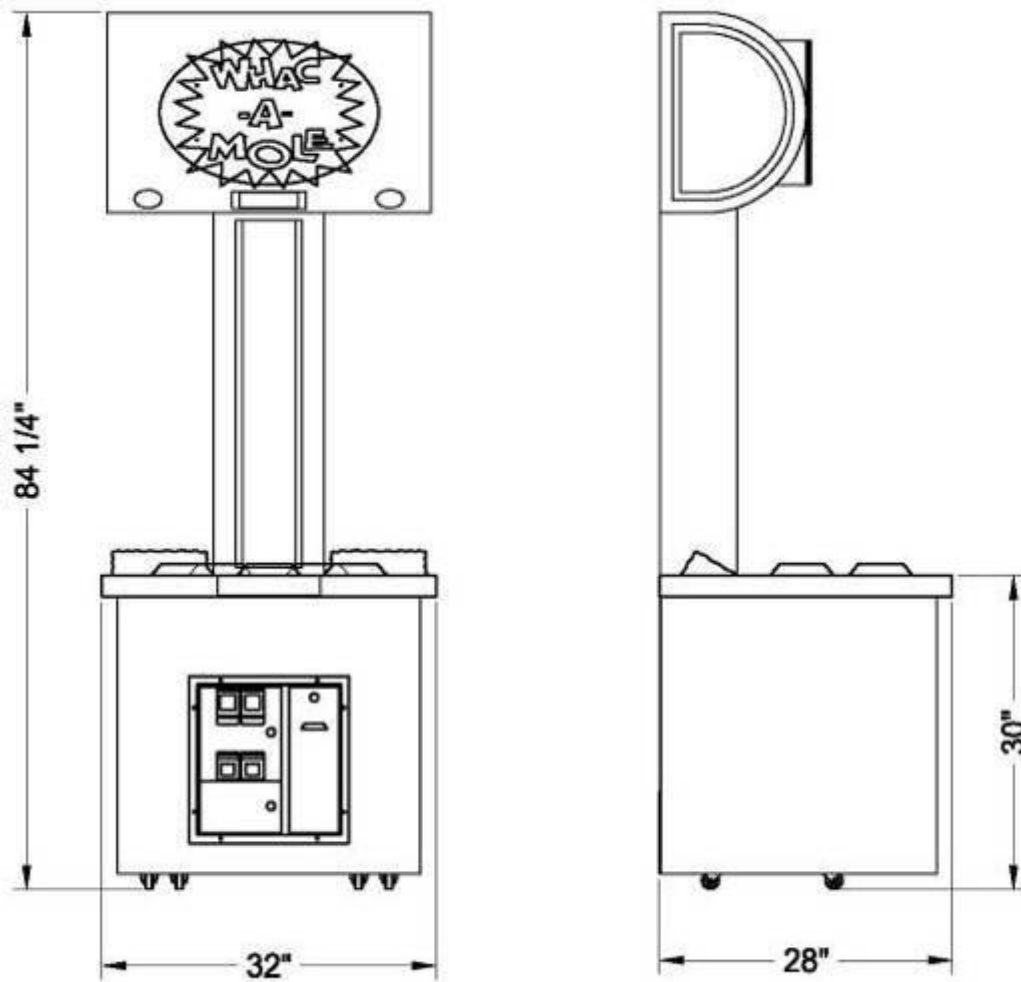

NOTE: Game parameters are subject to change without notice

INTRODUCTION

Overview:

Thank you for purchasing the new Whac-A-Mole[™] pro from Bob's space Racers! Built on a long tradition of quality and value, the new "pro" version Whac-A-Mole[™] retains all of the great game play of the original game yet is specifically designed for today's Arcade environment. New electronics technology was developed to maximize operation and revamp this arcade classic!

FEATURES:

New Solenoid Operation

The new solenoid design uses a heavy duty steel encapsulated high temperature bobbin developed specifically for this game. The "free floating" mounting system assures long life for the integral brass sleeve as well as the Annealed Chrome mole (solenoid) shafts. This design eliminates the air compressor, pistons and associated parts of the original design. This results in a lower cost, simpler and quieter design that is specifically tailored to the Arcade environment.

Cabinet Design

The new cabinet is designed to be lighter to make it easier to handle. It also incorporates a new marquee design that is fully back lit to attract players from across the room. New exciting graphics including a cute looking updated mole design to complete the package.

Electronics

The game utilizes all solid state circuitry for the ultimate in reliability.

Programming

The game has extensive programming options available to customize the game to your location.

Self Diagnostics

The game checks itself at power up to be sure that all of the solenoids and associated sensors and switches are functioning properly. If a failure is discovered, the game will display the problem on the score LED's.

Game Play

The game play is the same great play that generations have been entertained by. Hit those moles when they pop out of the holes. The faster you get, the faster they get. There is a special reward for getting the high score.

The score, high score of the day and bonus ticket amounts are indicated on the scoreboard.

The game plays until time runs out.

GAME SET-UP, OPERATION AND MAINTENANCE

Important Safety Information

WARNING: Unplug the game from the AC wall receptacle when servicing this product. Failure to do so could result in serious injury to yourself or others.

Use only a GROUNDED AC receptacle. Failure to do so could result in improper operation or damage to the game and could void your warranty. If you are unsure that your AC receptacle is properly grounded, have a qualified electrician perform this check for you.

Always be sure power to the game is turned off when doing even routine maintenance. Otherwise moving parts could activate unexpectedly and cause injury.

This product is heavy as necessitated by the design. When moving this game, be sure you have adequate help. Use a suitable dolly or hand truck where practical. Use back support when needed.



Set Up

1. Be sure that the game is on a level surface. If the game is rocking, use shims to remove the rocking of the game.
2. Be sure to plug the game into the proper A.C. GROUNDED receptacle. Do not use long extension cords unless absolutely necessary and if so, be sure it is a heavy duty cord of at least 16 Ga. and no longer than 20 ft. Check the label on the back of the game to make sure the power requirements of the game match that of your location.
3. Turn the game on and check to be sure there are no unusual sounds and that everything appears to be working correctly. When you first turn the game on, you will notice all of the moles taking turns popping up out of their holes. This is part of the diagnostic self test.

PACKAGE CONTENTS

Be sure to check that you have received all packages indicated below.

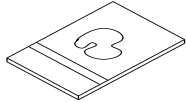
- (1) Game Unit
- (2) Accessories

NO	NAME	SPECIFICATION	QTY	ILLUSTRATION	NOTE
1	Power cord	10A/250V, 10 feet (Part # E0027145)	1		Wrapped up inside coin box.
2	Manual on CD	(M0013000) English	1		In a bag in the games ticket holder.
3	Keys	2111	8		Coin Box
4	Keys	2112	6		Deltronic Coin Mechanism

ATTENTION

● **For indoor use only!**

Installation

Check the parts list before installation. Verify that all parts that have been received and are in good condition.

Play zone (Operation Zone):

This machine requires space for playing the game. Be sure to leave enough space when installing the machine.

WARNING

- **Be sure to check the Electrical Specifications.** Ensure that this product is compatible with your location's power supply, voltage and frequency requirement. A plate describing Electrical Specifications is attached to the product. Non-compliance with the Electrical Specifications can cause a fire and electric shock.
- Putting many loads on one electrical outlet can cause generation of heat and a fire resulting from overload.

Locations to avoid:

WARNING

The machine is designed for indoor use only. Never install this machine outdoors or in any of the following:

- Locations exposed to direct sunlight
- Locations subject to rain or water leakage.
- Unstable locations or locations subject to vibration.
- Dusty, hot, or damp locations.

Game Leveling:

Install this machine on a flat surface. Adjust levelers to lift the legs and level game.

Make sure that the machine is level with the floor. If the machine is not level, the game may not play well.

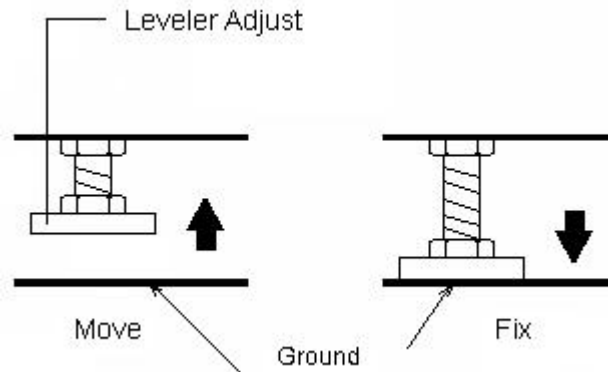

WARNING

- Disconnect game power before moving
- When moving the game, DO NOT slide the game across the floor
- Ensure the game is level before connecting the power

CONNECTING THE POWER CORD

1. Insert the socket end of power cord into the power input of the game.
2. Insert the power cord plug into a service outlet.

WARNING

- Do not put heavy items on power cord.

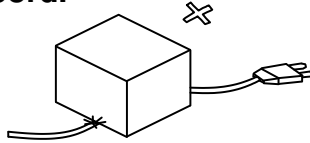

- Hold the power plug instead of the wire to draw the power cord out of the socket.

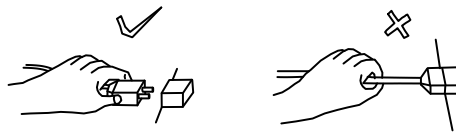

- Do not touch the power plug with wet hands.



- Do not draw or twist the cord or near a heat source.

- Do not place the cord where the player can easily trip over or come in contact with it.



- Operate this game with the correct power and fuse configuration. *(The machine's operating supply Voltage is 110VAC, please refer to the label on the machine. Improper voltage hookup may damage the machine, and may cause an electrical shock to an operator.)*

INSTRUCTION FOR PLAY

1. Insert coin(s), the game starts.
2. The object of the game is to hit the moles heads with the hammer as soon as the mole sticks its head out of the hole.
3. Beat the high score to receive bonus tickets.
4. Progressive speed modes have been added to increase the level of skill that it takes to achieve a higher score.

OPTION SETTINGS***Credit, Credit Time, Scores per Ticket***

Item	Content	SW1-DIP Positions							
		1	2	3	4	5	6	7	8
Credit	1	on	on						
	2	OFF	ON						
	3	on	off						
	4	off	off						
Credit Time	15			on	on	on			
	20			OFF	ON	ON			
	25			on	off	on			
	30			off	off	on			
	35			on	on	off			
	40			off	on	off			
	45			on	off	off			
50			off	off	off				
Scores Per Ticket	0						on	on	on
	10						off	on	on
	15						on	off	on
	20						off	off	on
	25						ON	ON	OFF
	30						off	on	off
	40						on	off	off
	50						off	off	off

Points for Hit, Mercy Ticket

Item	Content	SW2-DIP Positions							
		1	2	3	4	5	6	7	8
Points for Green Hit	10	ON	ON						
	9	off	on						
	8	on	off						
	5	off	off						
Points for Orange Hit	10			on	on				
	9			OFF	ON				
	8			on	off				
	5			off	off				
Points for Red Hit	10					on	on		
	9					off	on		
	8					ON	OFF		
	5					off	off		
Mercy Ticket	0							ON	ON
	1							off	on
	2							on	off
	3							off	off

Mole Speed, Attract, Music, Bonus Ticket

Item	Content	SW3-DIP Positions							
		1	2	3	4	5	6	7	8
Speed for mole	Slow	on	on						
	Mid	off	on						
	Fast	ON	OFF						
	Fastest	off	off						
Attract Mode	ON			ON					
	OFF			off					
Music	ON				ON				
	OFF				off				
Win Bonus Ticket	0					on	on		
	25					OFF	ON		
	50					on	off		
	100					off	off		

Bonus +, Max Bonus, Bonus Score to Win

Item	Content	SW4-DIP Positions							
		1	2	3	4	5	6	7	8
Bonus +	0	on	on						
	1	OFF	ON						
	2	on	off						
	3	off	off						
Max Bonus	0			on	on				
	50			off	on				
	100			on	off				
	250			OFF	OFF				
Bonus Score To Win	200					on	on	on	
	225					OFF	ON	ON	
	250					on	off	on	
	275					off	off	on	
	300							off	
	350							off	
	400							off	

MAINTENANCE AND INSPECTION

Maintenance

Due to the design of the machine, very little periodic maintenance is required.

Start the game and verify the correct operation before putting the game into everyday operations.

Clean the surface of the game as needed.

After about a month of game operation, check to be sure all parts are secure and in proper working order.

1. Remove power before servicing game.

To avoid a short circuit, the power must be removed before touching the inside of the game.

2. Choose the appropriate replacement parts.

Using the wrong parts could lead to malfunction or damage to the game and components.

3. Do not substitute or change equipment, without authorization.

Doing so could lead to a short circuit and machine malfunction, complete system failure and or fire.

4. Do not put containers of water, cups or soda cans on the machine. In addition, chemicals or heavy items should not be allowed around the game.

A spill of liquids or chemicals can seriously damage the sensitive electronic game components. Falling items could injure people or destroy the machine.

Cleaning

CLEANING - Clean the outer surfaces of the game with a commercial spray type cleaner.

DO NOT USE a glass cleaner or commercial chemical sprays on the marquee graphics panel.

DO USE a good quality spray type furniture polish to keep the game looking good.

Vacuum the inside of the game occasionally to help keep the dust and ticket debris off of all the optical sensors.

Clean Mole Shafts Regularly.

COIL BED SERVICING

The coil bed is the assembly that houses the solenoids, score sensors and Whac-A-Mole heads. This unit is built as an assembly to make servicing and repair easy. The entire unit removes from the game as a sub-assembly in just a couple of minutes.

Mole Head Shaft Cleaning

Procedure 1

A quick fix for a Shaft that is sluggish

Procedure 2

Cleaning Shafts without removing them from the game unit

This procedure should be performed every 2 weeks

Procedure 3

Removing Whac-A-Mole Heads for cleaning

This procedure should be performed every 3 months or less if required

Procedure 1 Instructions

A quick fix for a Shaft that is sluggish

Spray the Shaft with an all purpose Silicone Lubricant.

Note: Do not use graphite spray. It is conductive and you could short out the electrical wiring and/or the Printed Circuit Board (PCB).



Procedure 2 Instructions

Cleaning Mole Head Shafts without removing them from the game unit

1. Open the front of the game unit for access.

2. Remove the clip using a short flathead screwdriver.



3. Remove the washers from the shaft.



4. Lift the Mole Head out of the unit and remove the 3 washers from the top of the shaft.



5. Clean the shaft using a soft cloth.

Use an electrical contact / anti corrosion cleaner such as ElectriCorr VPCL – 239 or equivalent. Polish the shaft with Scotch bright. Remove any rust spots with an emery cloth.

5. Reassemble the shaft in the reverse order.

Procedure 3 Instructions

Removing Mole Heads for cleaning.

1. Turn off the A.C. power to the game.

2. Remove 4 bolts from the back of the game.



3. Remove metal strip



6. Unplug the 3 molex connectors.



7. Remove nuts and washers from the 4 Bolts that secure the tower (inside unit).



8. Remove the back of the tower.



7. Unplug the ribbon cable and carefully pull the ribbon cable and wires up through the tower.



9. Remove the tower from the game.



9. Unplug the ribbon cable from the 2 displays.



10. Carefully lift the top of the play field and unplug the molex connector.



Clip in front of play field that slides under cabinet top when reassembling play field.



11. Remove 4 bolts to the mole head assembly. (1 in each corner).



11. Unplug the molex connector in the back.

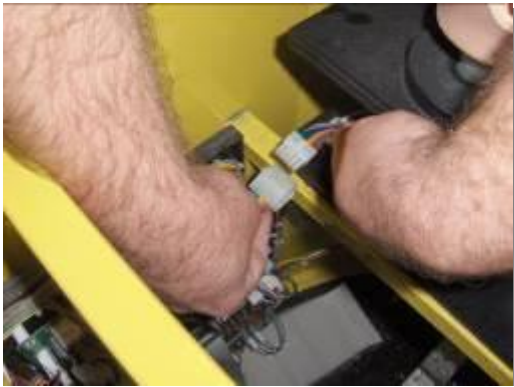

12. Unplug 2 more molex connectors in the front.



13. Lift the coil bed assembly out of the game.



14. Remove the clip using needle nose pliers or a small screwdriver.

16. Remove Mole Head from the Assembly by pulling it out and then remove the 3 washers from the shaft.

* Make note of the order of the washers on the top and bottom of the shaft.

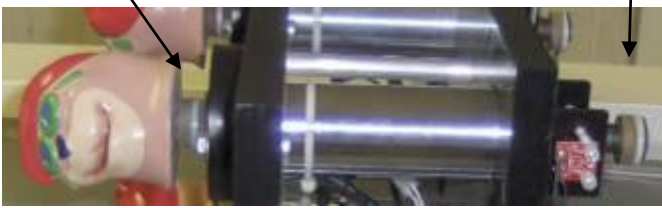

Clean the shaft using a soft cloth and an electrical contact / anti corrosion cleaner such as ElectriCorr VPCL – 239 or equivalent.
Polish the shaft with Scotch bright
Remove any rust spots with an emery cloth.

17. Spray the shaft with Dry Graphite Lubricant.



18. Clean the bore in the assembly with a gun cleaning kit. *Gun cleaning kits can be purchased at a local Wal-mart store.



19. Reassemble the washers on the top part of the shaft. *Note the correct order



20. Insert the shaft into the assembly.



21. Reassembly the washers. Note the correct order
Snap the clip back in place.
Repeat these steps for each of the Mole Head shafts.

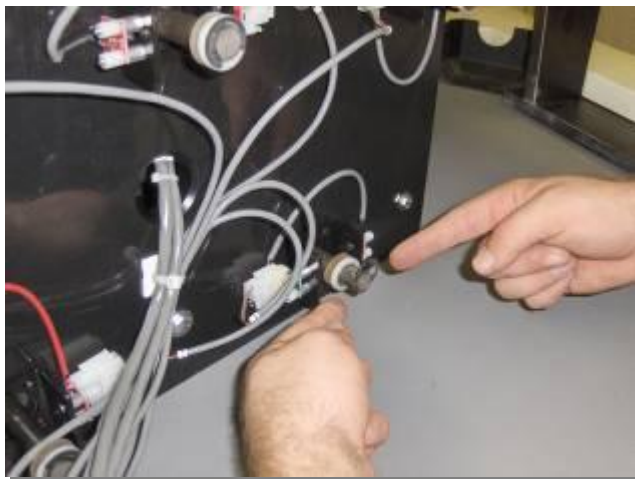

22. Return the coil bed assembly to the game
Plug in the Molex plug connectors.

23. Secure the coil bed assembly to the unit using the 4 bolts and washers.

24. Plug in ribbon cable to the display units.

25. Place tower unit back on the game and secure with the 4 nuts and washers.

26. Plug in the remaining ribbon cable and molex connectors.

27. Return the playfield to the game unit making sure the front clip slides under the cabinet top in the front.

27. Return the metal strip and secure with 4 bolts.

TROUBLESHOOTING

WARNING

For your safety, and to reduce risk of damage to your game read the Important Safety Information in Chapter 2-2 before attempting any troubleshooting procedure.

TROUBLESHOOTING PHILOSOPHY

When troubleshooting any product, certain general guidelines should be followed.

15. Always check to be sure that your game is turned on. Be sure that all of the fuses in the game are functional and check to see that the AC voltage is in the proper operating range for your game.
 16. Check to be sure that all of the game harnessing is plugged in properly and that all of the pins are firmly seated in the connectors. It is always possible that a harness can be damaged by rough shipping or moving.
 17. Check game harnessing to be sure that none of the wires have become or are damaged. Using a handheld multi-meter, check continuity of the wires to make sure they are not broken.
 18. Check for obvious damage to the P.C. Boards or electrical components.
 19. If you have multiple games or multiple parts on a game, change or exchange the parts and see if the problem goes away or moves to another location. This way you can quickly eliminate certain parts as being the problem with the game.
 20. When changing electronic or electrical components, ALWAYS turn off and unplug the game.
7. Check to see that all power supplies are delivering the specified voltages to the P.C. Boards and components as shown in the manual.

Trouble-Shooting Chart

Symptom	Possible Problem	Solution
	Power	Power
Sound Problems -No sound -Low Sound -Intermittent Sound	Low Volume Faulty speaker harnessing Faulty speaker Faulty sound board or sound board harnessing Faulty Main P.C. Board	Check Volume Control and adjust as necessary Check connections and/or repair harnessing Check and/or replace speaker Check connections or Replace Sound Board (See "Description C" below) Check and/or repair or replace Main P.C. Board
Game does not take or add money correctly	Coin switch out of adjustment Coin mech dirty or improperly adjusted Faulty Coin switch Faulty coin switch harness or connector Improperly programmed electronic mech Game improperly programmed Faulty Front Panel Board Faulty Main P.C. Board or component	Re-bend coin switch wire Clean and adjust mech as necessary Check and/or replace switch Check and/or repair harnessing Reprogram or replace electronic mech Check programming options and adjust Repair and/or replace Front Panel Board Repair and/or replace Main P.C. board
Ticket Dispenser not working properly, or no tickets being dispensed	No tickets in the game Tickets jammed in dispenser Ticket dispenser sensor blocked with debris Poor connection on the ticket dispenser Game improperly programmed Faulty ticket dispenser Faulty ticket dispenser harnessing Faulty Front Panel Board Faulty main PC board	Refill ticket dispenser and press the reset button Clear ticket jam Clean off sensor Check and/or replace connectors Check ticket programming options Replace dispenser Check and/or repair harnessing Repair and/or replace Front Panel Board Replace or repair Main P.C. Board
Game will not start	Game power off Faulty or unplugged sensor pair Main fuse blown Ground wire broken or loose Moles not working properly Faulty 12 volt power supply Faulty Front Panel Board Faulty Main P.C. Board or component	Check on/off switch and power cord Repair and/or replace sensor pair (See "Description B" below) Check and/or replace fuse as necessary Replace or tighten faulty ground wire See "moles won't pop up" below Check and/or replace the 12VDC power supply Repair and/or replace Front Panel Board Repair and/or replace Main P.C. Board
Game stops or is stopped with nothing displayed	The power connector is disconnected. The game could have a bad connection or short circuit.	Reconnect the connector securely. Check all circuitry for bad connection or short circuits.
Mole heads won't pop up	Excessive dirt or debris on solenoid shaft Solenoid shaft alignment Faulty sensor pair The current is too low. Faulty 36 volt power supply Faulty solenoid coil Faulty main P.C. board or component	Remove shaft and clean shaft and solenoid (See "Description A" below) Check that the bearing is evenly tightened Check and/or replace sensors Check and/or replace the 36VDC power supply Check and/or replace the 36VDC power supply Check coil resistance and replace solenoid coil Repair or replace main P.C. board
Mole head will not score	Disconnected sensor Faulty Connector or Connections Dirty Sensor Faulty Sensor.	Check connections. Check and/or replace Sensor Clean Sensor, (See "Description B" below) Check and/or replace Sensor, (See "Description B" below)
Noisy mole heads when they move up and down	The shaft has loosened and needs tighten. The mole shaft could be bent.	Tighten parts. (See "Description A" below) Check and/or replace mole shaft. (See "Description A" below)
Light bulbs are out	Lamps are burnt out Possible faulty socket connection Faulty ticket dispenser harnessing Faulty main PC board	Replace the lamps. Check connections and connectors Check and/or repair harnessing Replace or repair main PC board

ELECTRONIC / ELECTRICAL REPAIR

WARNING: Unplug the game from the AC wall receptacle when servicing this product. Failure to do so could result in serious injury to yourself or others.

Power Supply Replacement

21. Turn off A.C. power to the game and unplug the game from the A.C. receptacle.
22. Remove coil bed as indicated above in the “coil bed removal and installation” section.
23. Remove whichever power supply is faulty and replace.
24. Assemble in reverse order.

PCB Board Replacement

25. Turn off A.C. power to the game and unplug the game from the A.C. receptacle.
26. Remove the (2) bolts that attach the playfield to the top of the main cabinet.
27. Lift out and remove the playfield support frame from on top of the coil bed.
28. Replace the damaged board or bad fuse.
29. Assemble in reverse order.

NOTE: IF THE SOLENOID IS INSTALLED UPSIDE A LARGE LOSS OF SOLENOID STRENGTH WILL BE NOTED. INSTALLING THE SOLENOID UPSIDE DOWN MAY ALSO RESULT IN SOLENOID WIRE DAMAGE.

30. Re-install the solenoid plunger bearing making sure that the anti-rotation roll pin engages the notch in the top of the solenoid.
7. Re-install the bearing retaining bolts.

NOTE: INSTALL THE BOLTS EVENLY AND DO NOT OVERTIGHTEN. IF THE BOLTS ARE TIGHTENED UNEVENLY, SOLENOID PLUNGER SHAFT BINDING MAY OCCUR.

8. Re-assemble the rest of the game in reverse order. Refer to the specific sections of the manual if necessary.
9. Plug the game in and test for smooth solenoid operation.

Score Sensor Replacement

31. Remove coil bed as indicated above in the “coil bed removal and installation” section.
32. Unplug and unscrew the defective sensor pair and replace.
33. Assemble in the reverse order.

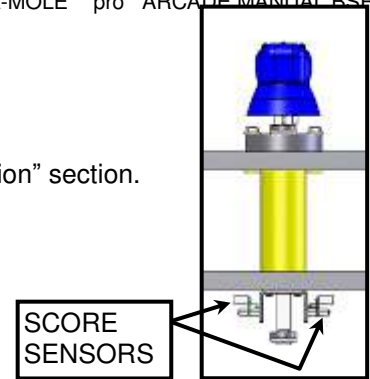

COIL BED
(FRONT VIEW)





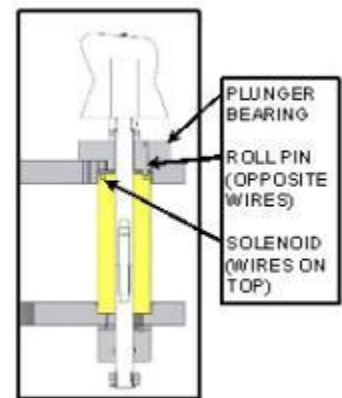

Solenoid Replacement

34. Remove coil bed as indicated above in the “coil bed removal and installation” section.
35. Remove the associated Mole head as indicated in the “mole head removal” section.
36. Remove the (2) 1/4-20 hex head bolts that hold the solenoid plunger bearing into the top of the coil bed assembly.
37. Unplug the bad solenoid and remove from the coil bed assembly.
38. Install the new solenoid making sure that the wires come out of the TOP of the solenoid and feed back down into the coil bed. There is a clearance notch in the top of the coil bed assembly for the solenoid wires.







COIL BED
(SECTION VIEW)

PARTS LIST

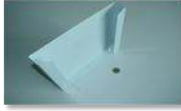
Reference Number	Part Number	Description	Image
WMP100-001-000	TBD	Power cord	
WMP100-001-001	TBD	Fuse	
WMP100-001-002	TBD	Ticket Dispenser	
WMP100-001-003	TBD	Electronic Coin Acceptor	
WMP100-001-004	TBD	Mechanism Coin Acceptor	
WMP100-001-005	TBD	3 In 1 Front Door	
WMP100-001-006	TBD	Speaker	
WMP100-001-007	TBD	Speaker Grill	
WMP100-001-008	TBD	Coil	<i>No Photo</i>
WMP100-001-009	TBD	Marquee Side LED long	
WMP100-001-010	TBD	Marquee Side LED Mid	

WMP100-001-011	TBD	Marquee Side LED Small	
WMP100-001-012	TBD	Marquee_led pcb	
WMP100-001-013	TBD	Marquee Spot Light	
WMP100-001-014	TBD	Control Panel _Spot Light	
WMP100-001-015	TBD	Sensor	
WMP100-001-016	TBD	Main board	
WMP100-001-017	TBD	Fan Grill	
WMP100-001-018	TBD	Fan	
WMP100-001-019	TBD	Ticket/Coin Meter	
WMP100-001-020	TBD	Meter Assembly	
WMP100-001-021	TBD	Ribbon Cable For three SEG on control Panel and top	
WMP100-001-022	TBD	Power Supply	

WMP100-001-023	TBD	Main Power Switch	
WMP100-001-024	TBD	Ticket Bin	
WMP100-001-025	TBD	PCB	
WMP100-001-026	TBD	PCB	
WMP100-001-027	TBD	PCB	
WMP100-001-028	TBD	Display	
WMP100-001-029	TBD	Mole Head (with metal holder)	
WMP100-001-030	TBD	LED Panel	
WMP100-001-031	TBD	Whole set of cable	<i>No Photo</i>
WMP100-001-032	TBD	Bottom Cabinet	
WMP100-001-033	TBD	Top Side Acrylic (with decal)	
WMP100-001-034	TBD	Fiberglass Control Panel	

WMP100-001-035	TBD	Fiberglass Top Part (with service door)	
WMP100-001-036	TBD	Billboard with Acrylic and Decals	
WMP100-001-037	TBD	Fill Acrylic for SEG Display	
WMP100-001-038	TBD	Fill Acrylic for Displays	
WMP100-001-039	TBD	Lock_3157	
WMP100-001-040	TBD	Key_3157	
WMP100-001-041	TBD	Lock_3172	
WMP100-001-042	TBD	Key_3172	

WARRANTY**BOB'S SPACE RACERS, INC.
90 DAY COIN-OPERATED GAME WARRANTY**

1. INCLUDED IN THIS WARRANTY Bob's Space Racers[®], Inc. warrants to the original purchaser only that the equipment that is the subject of this sale conforms to its specifications, and is free from defects under normal service for a 90 day period from the original date of deliver. This warranty does not include any damages resulting from occurrences listed in paragraph 2 below. This warranty is not transferable under any circumstance. Any claims under this warranty must be received in writing by Bob's Space Racers[®], Inc. within 120 days from date of delivery. Within a reasonable time of such written notification Bob's Space Racers[®], Inc. will replace or repair any defective component of the equipment or part thereof which fails for reasons other than normal service, use, or wear. Bob's Space Racers[®], Inc. reserves the right to request dated proof of purchase by the end user (original purchaser) at any time. Light bulbs are specifically excluded from this warranty and shall be the sole responsibility of the purchaser. Bob's Space Racers[®], Inc., within its sole discretion, makes the final determination as to whether to repair or replace any component and whether any such repair or replacement shall be performed where the equipment is located or at it's home facility in Volusia County, Florida, or another facility of its sole choice. Any and all freight charges for the purposes of repair or replacement shall be paid by the original purchaser. All defective parts shall be returned to Bob's Space Racers[®], Inc. if requested. Bob's Space Racers[®], Inc. does not warrant that the equipment will meet any original purchaser's specific requirements or that the operation of the equipment will be uninterrupted. These remedies are the original purchaser's exclusive remedies for breach of warranty.
2. EXCLUDED BY THIS WARRANTY Bob's Space Racers[®], Inc. does not warrant (a) any product, components or parts not manufactured by Bob's Space Racers[®], Inc.; (b) damages caused by use of the equipment for purposes other than those for which it was designed; (c) defects caused by failure to provide a suitable installation environment for the equipment; (d) damage caused by unauthorized attachments, modification, or service; (e) damage caused by normal wear and tear or improper power supply; (f) damage caused by accident or disaster such as fires, flood, lightning, and wind; or (g) any other abuse or misuse of the equipment.
3. EXCLUSIVE WARRANTY. THE FORGOING WARRANTY IS EXCLUSIVE AND IN LIEU OF ALL OTHER WARRANTIES OR REMEDIES, WHETHER WRITTEN, ORAL OR IMPLIED. THERE ARE NO WARRANTIES WHICH EXTEND BEYOND THE DESCRIPTION ON THE FACE HEREOF. ANY AND ALL IMPLIED WARRANTIES OF MERCHANTABILITY, FITNESS FOR A PARTICULAR PURPOSE, COURSE OF DEALING OR USAGE OF TRADE ARE HEREBY EXPRESSLY DISCLAIMED AND EXCLUDED.
4. REMEDIES LIMITED. UNDER NO CIRCUMSTANCES, EXCEPT TO THE EXTENT PROHIBITED BY APPLICABLE LAW, SHALL BOB'S SPACE RACERS[®], INC. BE LIABLE FOR ANY LOSS OR DAMAGE, DIRECT OR INDIRECT, SPECIAL INCIDENTAL OR CONSEQUENTIAL ARISING OUT OF THE USE OR INABILITY TO USE THIS EQUIPMENT INCLUDING BUT NOT LIMITED TO ANY CLAIM FOR LOSS OR PROFITS, LOSS OF SAVINGS OR REVENUE, LOSS OF USE OF THE EQUIPMENT, OR ANY ASSOCIATED EQUIPMENT, FACILITIES OR SERVICE, DOWNTIME, THE CLAIMS OR COSTS OF THIRD PARTIES INCLUDING CUSTOMERS AND INJURY TO PROPERTY. Some states do not allow limitations on how long an implied warranty lasts or the exclusion or limitation of incidental or consequential damages, so the above limitations or exclusion may not apply to you. This warranty gives you specific legal rights, and you may also have other rights which vary from state to state.
5. NO OTHER WARRANTIES. Unless modified in writing and signed by both parties, this agreement is understood to be the complete and exclusive agreement between the parties, superseding all prior agreements, oral or written, and all other communications between the parties relating to the subject matter of this agreement. No employee or representative of Bob's Space Racers[®], Inc. or any other party is authorized to make any other warranty or to assume any other liability in connection with the sale of its equipment.
6. TIME LIMIT FOR CLAIMS. Any claim for breach of warranty or claims under this warranty must be received in writing by Bob's Space Racers[®], Inc. within 120 days following delivery of the equipment.
7. FUTURE CHANGES. Bob's Space Racers[®], Inc. reserves the right to reserve, change or modify the construction and design of its equipment or any component part or parts thereof without incurring the obligations to make such changes or modifications in present equipment.
8. ALLOCATION OF RISKS. This agreement allocates the risks of equipment failure between Bob's Space Racers[®], Inc. and the original purchaser. This allocation is recognized by both parties and is reflected in the price of the goods. THE PURCHASER ACKNOWLEDGES THAT HE HAS READ THIS AGREEMENT, UNDERSTANDS IT, AND IS BOUND BY ITS TERMS.
9. TO OBTAIN WARRANTY SERVICE. The original purchaser must, at his/her own expense, bring or ship the equipment to an authorized location for service. Additionally, the original purchaser must pay all freight, shipping or transportation charges for the return of the equipment from Bob's Space Racers[®], Inc. to the original purchaser. Telephone or write:

WHEN CALLING FOR SERVICE

1. When calling for service, please check the service manual first. Many times the answer to your problem has been addressed in this documentation.
2. Please make sure you have the serial number of the game ready when you call.
3. If this is a repeat call, please tell the service technician that you have made a previous call regarding this problem. This way we will be able to retrieve the history on your game allowing us to serve you better and save you time.
4. Please retain proof of purchase for your product. This might be requested for warranty repairs.
5. Please call from the game if possible since we might need you to check certain things on the game while we are on the telephone with you.

IF YOU HAVE ANY QUESTIONS OR COMMENTS, PLEASE CALL OUR SERVICE DEPARTMENT AT

(386) 677-0761

(MONDAY – FRIDAY, 8:30AM – 5:00PM EST, EXCLUDING HOLIDAYS)

(or)

EMAIL QUESTIONS TO: Tech@BobsSpaceRacers.com

(or)

VISIT THE “CUSTOMER SUPPORT” SECTION ON OUR WEBSITE:

WWW.BOBSSPACERACERS.COM

427 15th Street

Daytona Beach, FL 32117

Telephone number: 386/677-0761

FAX: 386/677-0794