



# TICKET MONSTER

PLACE SERIAL NUMBER LABEL HERE



# FACTORY CONTACT INFORMATION



BAY TEK GAMES INC.  
Pulaski Industrial Park  
1077 East. Glenbrook Drive  
Pulaski, WI 54162 USA

## JOIN OUR SERVICE FIRST NETWORK!

This free service is intended to keep you up to date on the latest game information, early notification of parts specials, pertinent technical bulletins, updates on retro fit parts, software upgrades, and much more.

Log on to: [www.baytekgames.com/parts](http://www.baytekgames.com/parts)  
then click on the Parts N' Service tab, or scan the QR code to the right with your Smartphone to jump straight to this game's parts page!

Scan here!



### SALES

P: 920.822.3951

F: 920.822.8936

E: [sales@baytekgames.com](mailto:sales@baytekgames.com)

### PARTS

P: 920.822.3951 X 1101

F: 920.822.1496

E: [parts@baytekgames.com](mailto:parts@baytekgames.com)

### SERVICE

P: 920.822.3951 X 1102

F: 920.822.1496

E: [service@baytekgames.com](mailto:service@baytekgames.com)

MON - FRI  
8 AM - 5 PM C.S.T.

All games are proudly manufactured at our factory in Pulaski, Wisconsin, USA

# TABLE OF CONTENTS

FACTORY CONTACT INFORMATION .....	2
WELCOME TO: TICKET MONSTER .....	4
HOW TO PLAY .....	5
SPECIFICATIONS .....	6
SAFETY PRECAUTIONS .....	6
SETUP GUIDE .....	7-10
OPENING THE WHEEL WINDOW .....	11
MAIN MENU FUNCTIONS .....	12-16
TICKET PATTERNS .....	14-15
KEY COMPONENTS .....	17
MOTHERBOARD PINOUT .....	18
AUX BOARD PINOUT .....	19
HOW TO: CALIBRATE ENCODER SENSOR .....	20
HOW TO: ADJUST BRAKE .....	21
HOW TO: REMOVE HANDLE .....	22
HOW TO: TIGHTEN ARM BRACKET .....	22
DOOR OPEN ERROR .....	23
PUPPY VIDEO WIZARD ERROR .....	24
POWER SUPPLY DIAGNOSTICS .....	25
TROUBLESHOOTING GUIDE .....	26-34
MAINTENANCE LOG .....	35
TECHNICAL SUPPORT .....	36
WARRANTY .....	37
COMPLIANCE CERTIFICATE .....	38

# WELCOME TO: TICKET MONSTER

## **Congratulations on your Ticket Monster purchase!**

Larger than life and not-so-creepy, Ticket Monster is sure to roll in scary big revenues!

With a progressive jackpot, fresh theme and brightly colored cabinet, Ticket Monster will lure in players from across the room.

Please take a moment to read through this manual and be sure to contact our factory if you have any questions, or would like some more information.

Thank you for your purchase! Your business is important to us and we hope you enjoy this game as much as we do!

*Your Friends at Bay Tek Games*



## **GAME INSPECTION**

Inspect the game for any damaged, loose, or missing parts.

If damage is found, please contact your freight carrier first.

Then, contact Bay Tek Games' Service Department at 920.822.3951 or e-mail them at [service@baytekgames.com](mailto:service@baytekgames.com) for further assistance.

# HOW TO PLAY

Lift up on the handle and push it down hard.



Roll the monster's tongue around.



Win tickets where the arrow points.



Land on the Jackpot space to win scary big tickets!













# GAME SPECIFICATIONS

WEIGHT	
NET WEIGHT	1000 LBS
SHIP WEIGHT	1200 LBS
DIMENSIONS	
WIDTH	32"
DEPTH	90"
HEIGHT	117"
OPERATING TEMPERATURE	
FAHRENHEIT	80-100
CELSIUS	26.7-37.8

POWER REQUIREMENTS			
INPUT VOLTAGE RANGE	100 to 120 VAC	/	220 to 240 VAC
INPUT FREQUENCY RANGE	50 HZ	/	60 HZ

MAX START UP CURRENT	OPERATING CURRENT
3 AMPS @ 115 VAC	0.7 AMPS @ 115 VAC
1.5 AMPS @ 230 VAC	.35 AMPS @ 230 VAC

# SAFETY PRECAUTIONS

 <b>DANGER</b> 
DO NOT perform repairs or maintenance on this game with the power ON. Unplug the unit from the wall outlet or shut off the power strip located inside the cabinet.
 <b>WARNING</b> 
Use of flammable substances can cause sever burns or serious injury. Always use NON-FLAMMABLE solvents for cleaning. DO NOT use gasoline kerosene or thinners.
 <b>CAUTION</b> 
Lifting heavy objects can cause back, neck or other injuries. Be sure adequate lifting and moving devices are available when unloading, unpacking and moving this game.
 <b>ATTENTION</b> 
Be sure the electrical power matches the game requirements. See the serial number located on the back of the game cabinet. Always plug into a grounded circuit. If the supply cord is damaged, it must be replaced by an approved cord or assembly provided by the manufacturer.
 <b>IN CASE OF EMERGENCY</b> 
UNPLUG THE POWER CORD. The power cord must be accesible at all times in case of an emergency.

# SET UP GUIDE

Place the wood “sled” on top of the cabinet, lining up the holes and making sure the black power cable, monitor VGA cable, and grey phone cable with splitter jumper feed through to the top without getting pinched.



Pivot the black metal tube up into position.



Secure metal tube with two bolts, washers and nuts from hardware kit, and tighten with 7/16” wrench.

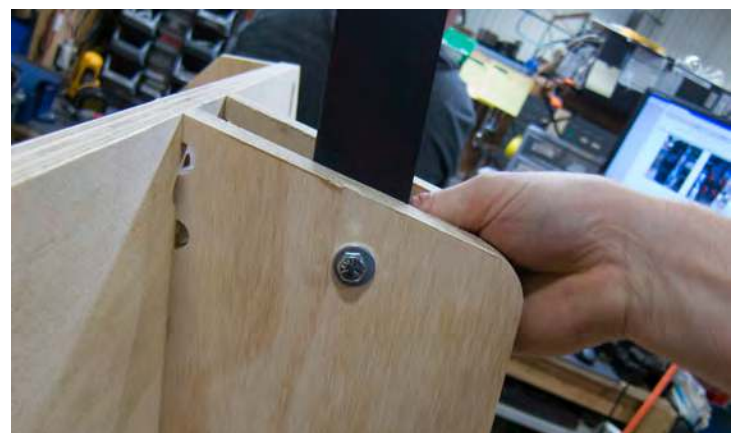

## SET UP GUIDE, CONT.

Secure the monitor mount sled to the cabinet with the included hex bolts, split washers and washers into the 4 holes shown using a 7/16" ratchet. No nuts are required; T-nuts are built into the top of the cabinet.



Plug the power and VGA cables from the cashbox into the cables coming out the top of the cabinet.



Feed the power and VGA cables up through the metal tube.



Attach the wings with bolts, washers, and nylon nuts and a 9/16" ratchet socket and wrench. The wings should pivot at the bolts, opening wide enough to fit the blue plastic head in between.

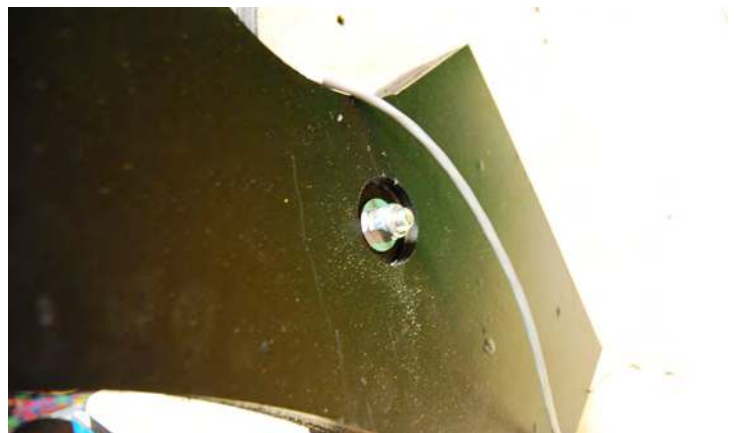



## SET UP GUIDE, CONT.

Plug in the wing cables to the jumper on the grey phone cable.



Place the blue monster head onto the top of the cabinet, inserting the wings into the slots and the black metal tube through the square hole in the top.



Attach the monitor to the metal tube with included lock nuts and a 1/2" nut driver.

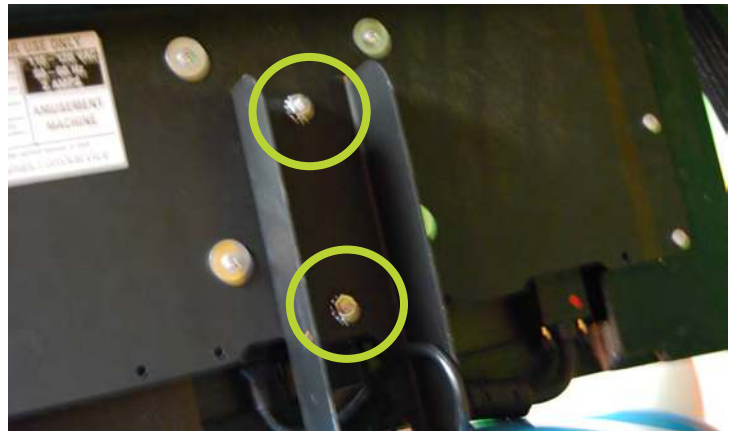

Push the wings inward, sliding in front of the brackets on the monitor. Secure the brackets to the wings with included silver screws.



## SET UP GUIDE, CONT.

Plug the power and VGA cables into the monitor.

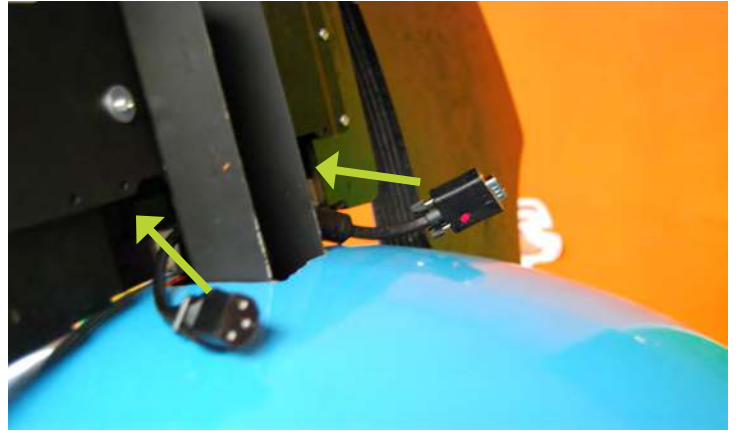

Plug the power cable from the cashbox into the line filter on the back of the game and into a standard electrical outlet.



If the game doesn't power up on plug in, switch the power strip inside the right front door to ON.



Attach the side guards with the included bolts, washers, split washers and lock nuts; 4 bolts in each side.



# OPENING THE WHEEL WINDOW

On occasion, it will be necessary to clean the insides of the windows, which requires access to the inner wheel area of the game.



Open the front doors and locate and release the two latches near the top inside corners.



Slide the plexiglass window up and away from you.

# MAIN MENU

The menu buttons are located inside the left front door.

Press MENU BUTTON to access the main menu.

Scroll through the menu with the MENU BUTTON.

Make selections with the MENU SELECT button.

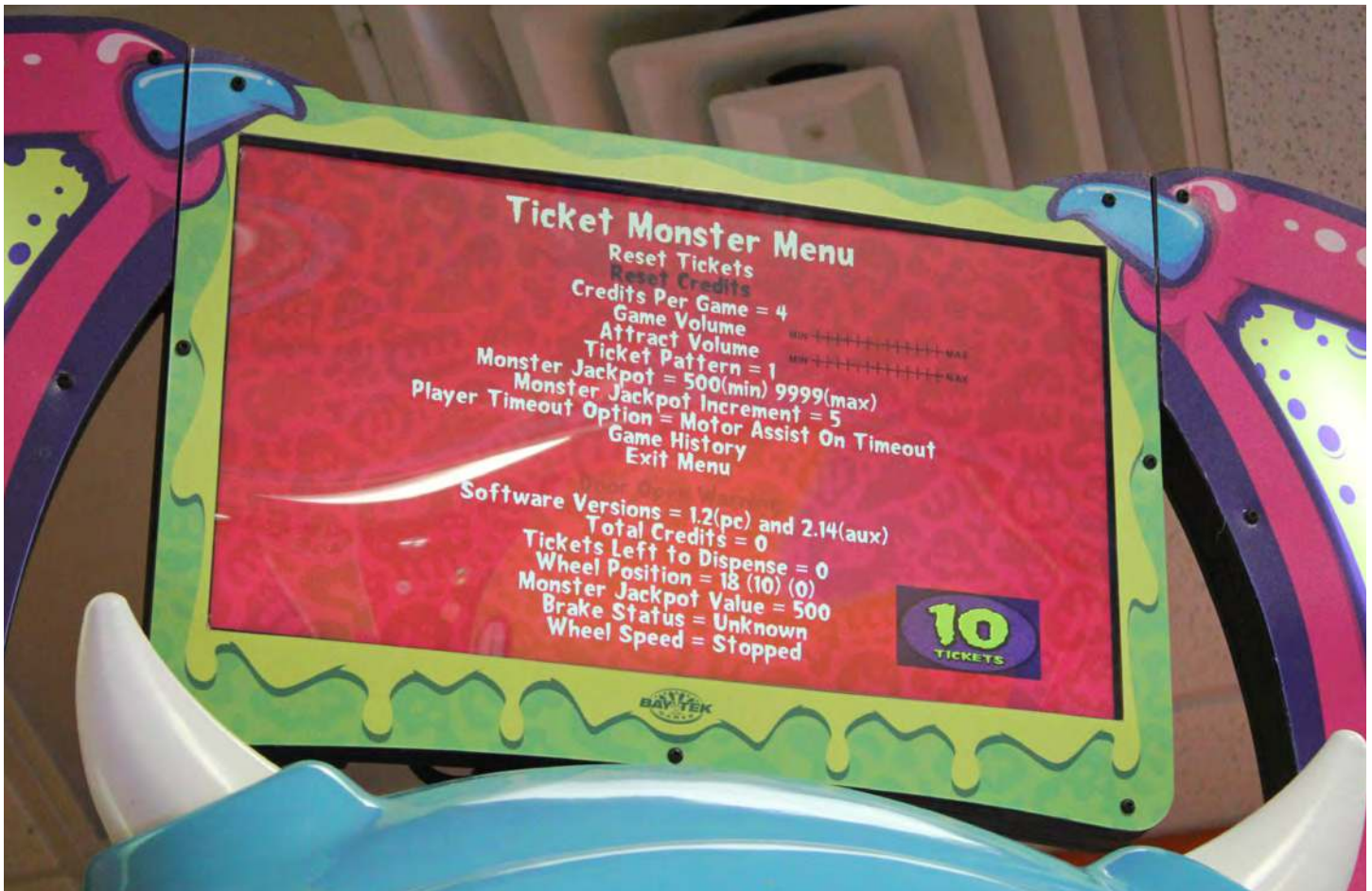
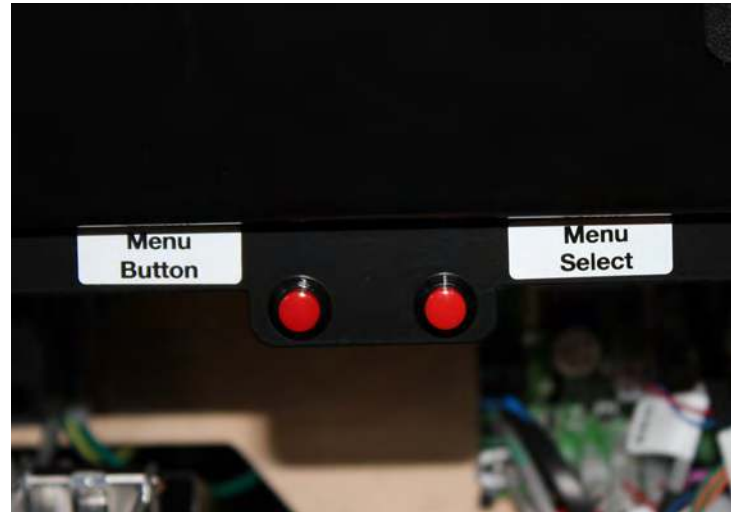

The main menu will appear on the monitor.

If the angle of view makes menu options slightly hard to see, we recommend dimming the ambient lighting to better see the monitor.

# MAIN MENU

## GAME SETTINGS

Reset Tickets	Clears all tickets waiting to be paid out													
Reset Credits	Clears all credits on the game													
Credits per Game	0	1	2	3	4	5	6	7	8	9	10	12	20	
	\$5 bill bonus:				6 plays for \$5				3 plays for \$5					
Game Volume	Adjusts the volume of the game while coined up and playing													
Attract Volume	Adjusts the volume of the game while in attract mode													
Ticket Pattern (see page 14 for available alternate patterns)	1	2	3	4	5									
Jackpot Menu	see table below													
Player Timeout Option	Auto Spin				Abandon Game (required for New Jersey)				No Timeout (required for WA state)					
Game History	Opens a new screen with detailed game play and payout log													
Set Time & Date	Opens a new screen with date and time selections													
Exit Menu	Returns game to normal function													

## JACKPOT MENU

Monster Jackpot (Min/Max)	50/250		50/500		50/1000			100/500			100/1000	
	100/2500			250/1000			250/2500			250/5000		
	250/9999			500/1000			500/2500			500/5000		
	500/9999			1000/2500			1000/5000			1000/9999		
Jackpot Increment	1	2	3	4	5	6	7	8	9	10	DISABLED	
Jackpot Reset	Reset the jackpot payout to the minimum value established above											
Machine ID*	1 (master)			2			3			4		

\*If you plan to link two or more games to increment their jackpots simultaneously, a linkage kit is required. Please call our service department to order.

# TICKET PATTERNS

# TICKET MONSTER-TICKET PATTERNS

**PATTERN 1**  
DEFAULT

4	MONSTER JACKPOT	4
25		
40		
15		
40		
4	100	4
10		
30		
40		
4	100	4
25		
40		
15		
40		
4	100	4
10		
30		
40		

32-35  
TICKETS/GAME  
PART #: AATP0201

**PATTERN 2**

4	MONSTER JACKPOT	4
25		
75		
30		
75		
4	250	4
10		
80		
40		
4	250	4
25		
75		
30		
75		
4	250	4
10		
80		
40		

50-53  
TICKETS/GAME  
PART #: AATP0202-P

**PATTERN 3**

4	MONSTER JACKPOT	4
25		
40		
50		
150		
4	250	4
75		
30		
40		
4	250	4
25		
75		
50		
150		
4	250	4
75		
30		
40		

60-63  
TICKETS/GAME  
PART #: AATP0203-P

**PATTERN 4**

4	MONSTER JACKPOT	4
15		
10		
15		
10		
4	50	4
10		
15		
10		
4	50	4
15		
10		
15		
4	50	4
10		
15		
10		

14-17  
TICKETS/GAME  
PART #: AATP0204-P

**PATTERN 5**

4	MONSTER JACKPOT	4
50		
60		
40		
150		
4	500	4
40		
80		
70		
4	500	4
40		
60		
40		
70		
4	500	4
150		
80		
70		

74-77  
TICKETS/GAME  
PART #: AATP0205-P

**PATTERN 6**

4	MONSTER JACKPOT	4
25		
75		
30		
40		
4	250	4
10		
50		
40		
4	250	4
25		
75		
30		
40		
4	250	4
10		
50		
40		

40-45  
TICKETS/GAME  
PART #: AATP0206-P

# TICKET PATTERNS

# TICKET MONSTER-TICKET PATTERNS

**PATTERN 7**  
(CEC Franchise)

MONSTER JACKPOT
2
10
2
5
25
5
2
5
25
2
10
2
5
25
5
2
10
2
5
25
5
2
10
2
5
25
5

7-9  
TICKETS/GAME  
PART #: AATP0207-P

**PATTERN 8**

MONSTER JACKPOT
15
10
15
40
100
10
25
10
50
15
10
15
40
50
15
10
15
40
50
15
10
25
10

23-26  
TICKETS/GAME  
PART #: AATP0208-P

**PATTERN 9**

MONSTER JACKPOT
15
10
15
40
50
10
25
10
50
15
10
15
40
50
15
10
15
40
50
15
10
25
10

19-22  
TICKETS/GAME  
PART #: AATP0209-P

**PATTERN 10**

MONSTER JACKPOT
25
40
25
10
100
10
30
10
100
25
40
25
10
100
25
10
30
10

27-30  
TICKETS/GAME  
PART #: AATP0210-P

**PATTERN 11**

MONSTER JACKPOT
25
75
15
40
100
10
50
40
100
25
75
15
40
100
25
10
50
40

38-41  
TICKETS/GAME  
PART #: AATP0211-P

**PATTERN 12**

MONSTER JACKPOT
25
40
50
150
250
75
80
40
250
25
75
75
50
150
250
75
80
40

23-26  
TICKETS/GAME  
PART #: AATP0212-P

# MAIN MENU, CONT.

## DIAGNOSTICS

Door Open Warning	Indicates when any of the 5 access doors is open
Software Version	Indicates which version of software is installed on the game
Total Credits	Indicates how many credits are available on the game
Tickets Left to Dispense	Indicates number of tickets waiting to pay out
Wheel Position	Indicates wheel position for calibration and diagnosing problems
Inputs	Indicates how many inputs (buttons, etc.) are active
Outputs	Indicates how many outputs are active
Brake Status	Indicates if the brake is OK, too tight or too loose
Wheel Speed	Indicates how fast the wheel is spinning

## DIAGNOSTICS

Total Games	Number of games played since last statistics reset
Total Tickets	Number of tickets dispensed since last statistics reset
Tickets per Game	Average number of tickets dispensed per game
Total Motor Assists	Number of games in which the motor spun the wheel for the player



# KEY COMPONENTS

## Wheel Encoder Sensor

(AACB1901)

Located inside left side access door.

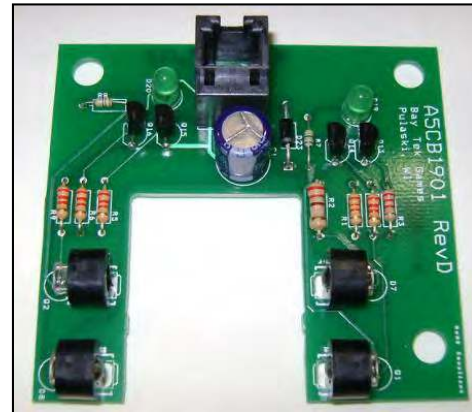

## I/O Board

(AACB1900)

Located inside left front door.

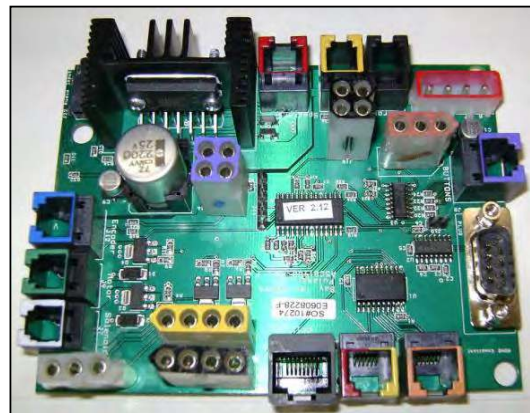

## Motherboard

(AAMB8)

Located inside right front door.

Includes software hard drive (A5HD1800) and RAM (A5CB1904).



## Software Hard Drive

(A5HD1800)

Located in a SATA port on the Motherboard.

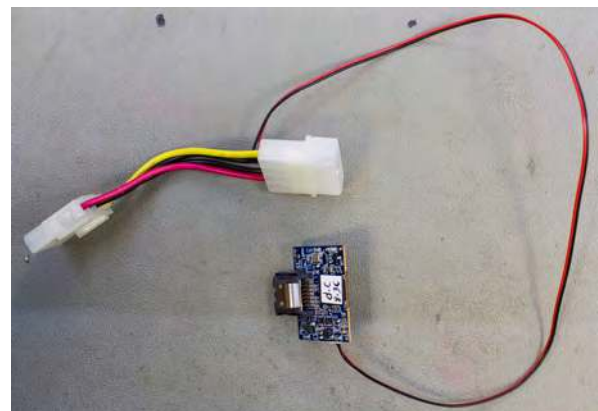

# MAINBOARD PINOUT (MB8)

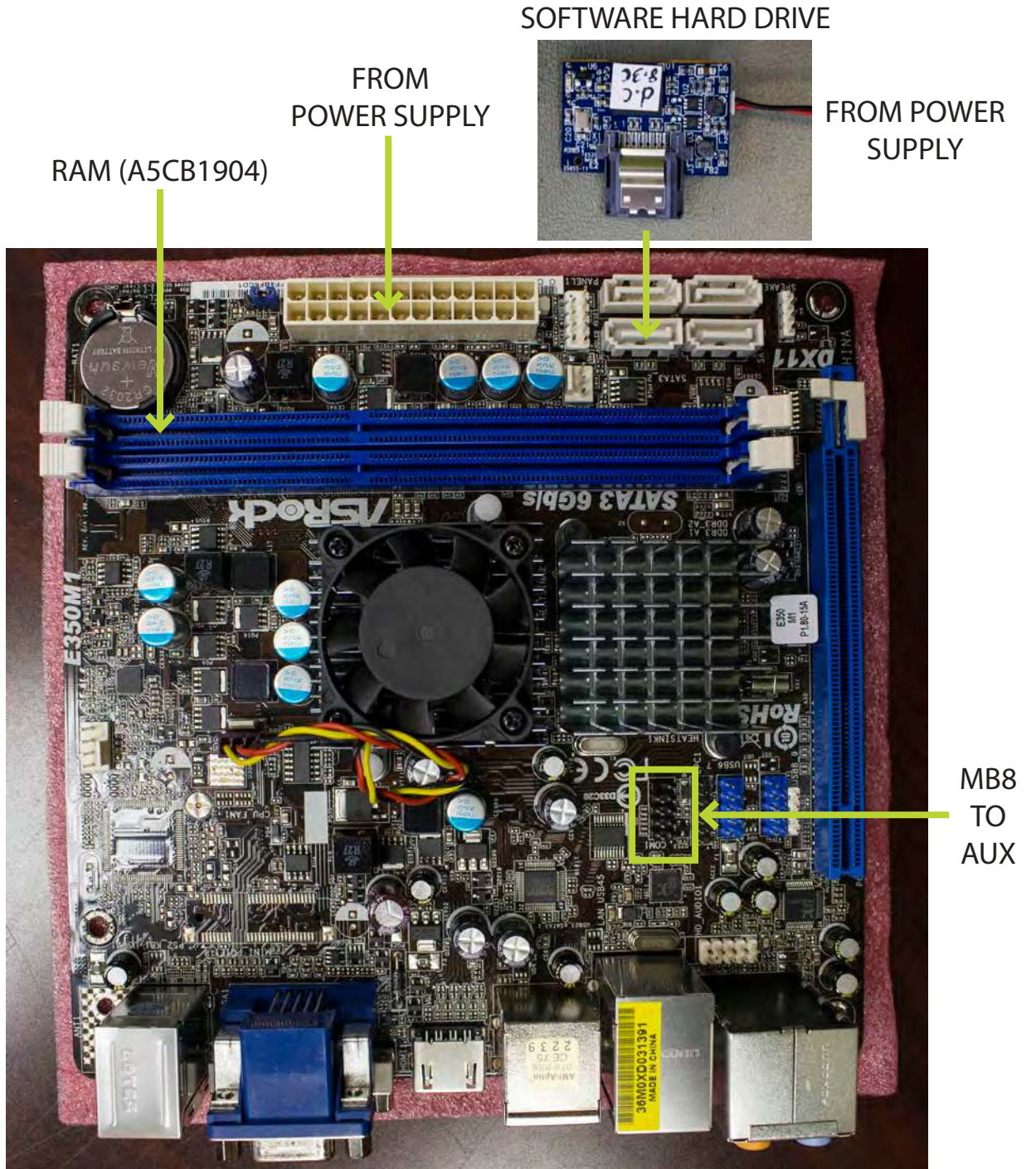

# AUX BOARD PINOUT (A5CB1900)

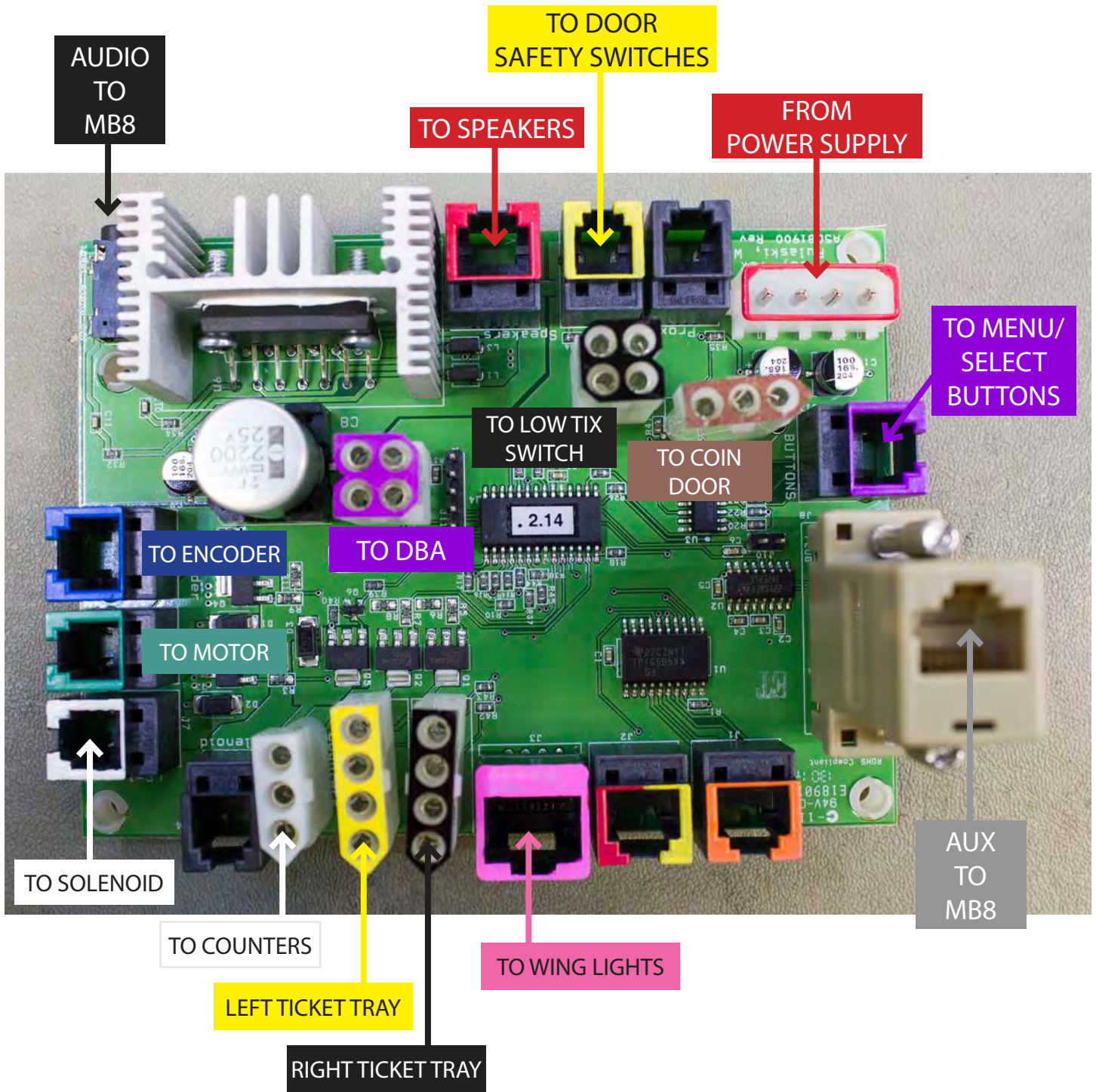

# HOW TO: CALIBRATE ENCODER SENSOR

The Encoder Sensor communicates the position of the wheel in comparison to the orange arrow, telling the game how many tickets the player has won.

There is a small margin between scoring spaces that allows for slight miscalibration of the encoder sensor.

If the arrow lands between spaces, the game will always award the player with the higher ticket value.

This also applies on the bonus spaces.

Open the wheel window (see page 11) and access the main menu.



Manually turn the wheel downward and make sure the ticket value displayed on the screen matches the space the arrow is pointing to. Make sure to turn the wheel one complete revolution so the game can find the home position.



Turn the wheel as it approaches a bonus section. Watch the display closely, and stop the wheel as soon as it turns from a 4 to the bonus value. The arrow should be right on the line between 4 and the bonus space.



## If the pointer is more than 1/2" off:

Open the left side door and locate the two Phillips head screws on the sensor bracket which hold it securely in the adjustment slots.

Loosen the screws and move the bracket slightly, then retighten and restest.

Repeat as necessary.



# HOW TO: ADJUST BRAKE

Wheel Coast Time is determined by how long the wheel spins before it comes to a complete stop. Long coast time increases the time per game, while a short coast time makes the game quicker. The higher the number, the longer the wheel coasts; the ideal coast time is between 30 and 40. Adjusting this number periodically will prevent skilled players from sharking the game.

## To test Wheel Coast Time:

While in the main menu, spin the wheel. The display should read "good spin".

Once the wheel stops, the brake status will come up in the diagnostics.

## Brake status will show one of three options:

- Brake OK (no adjustment needed)
  - Tighten Brake
  - Loosen Brake

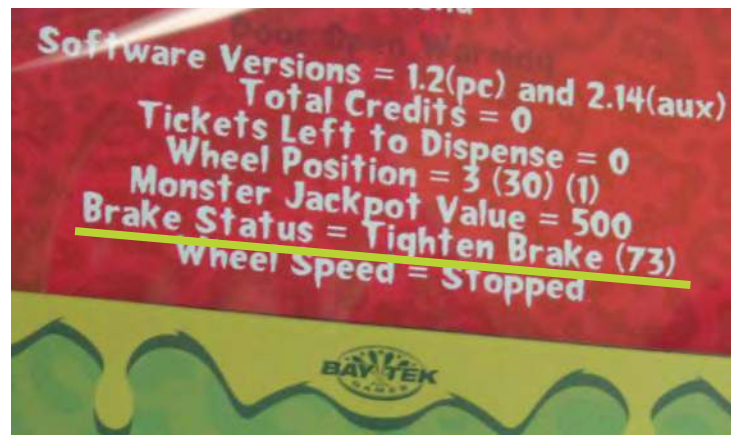

Open the left side door and locate the brake.

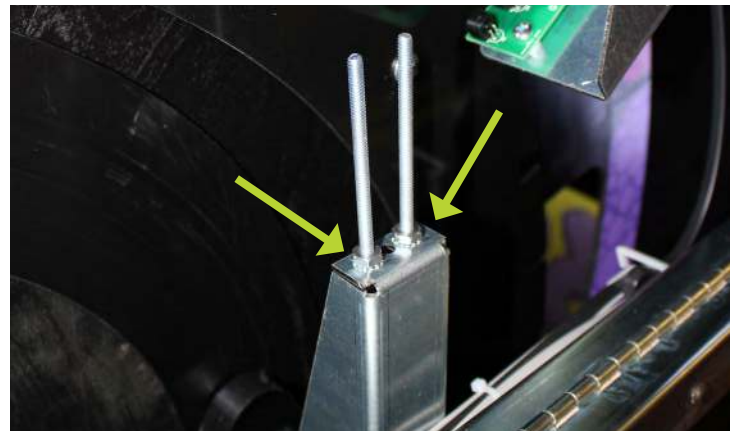

Pull up each bolt and turn the locknuts left to tighten or right to loosen. Move in 2-turn increments; the brake is sensitive and needs very little adjustment to make a difference. Make sure each bolt is adjusted equally.

Perform another Wheel Coast Time test and check the brake status. Repeat previous steps until brake status reads OK.

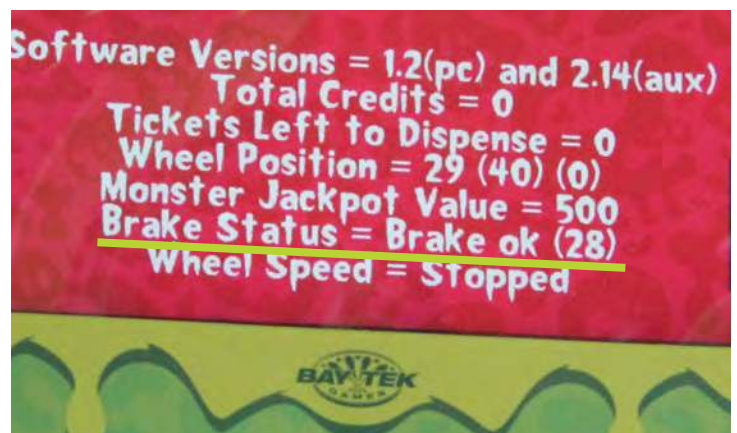

# HOW TO: REMOVE HANDLE

## Tools Needed:

1/2" Socket & ratchet

1/2" Wrench

Located on the underside of the metal front panel, there is a bolt, split washer, and locknut holding the handle into the square pipe attached to the linkage.

Remove the bolt by turning the ratchet on the locknut and holding the bolt still with the wrench.

Pull the handle out from the front of the game.

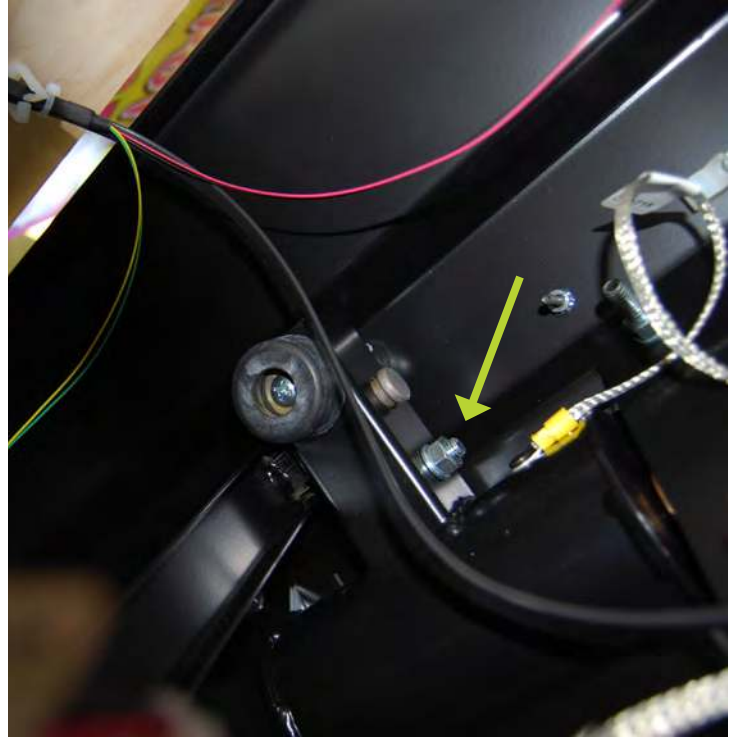

# HOW TO: TIGHTEN ARM BRACKET

It is important to keep the arm bracket securely tightened; failure to do so may cause injury to players or damage to the game.

We recommend checking the bolts monthly, and more often if the game accumulates a high volume of play.

Open the right front door and remove the acrylic shield using a 90 degree drill and square bit.

Check the 6 bolts holding the bracket in place- 3 on the front surface and 3 on the bottom- and tighten all nuts with a 7/16" socket.

Replace acrylic shield.



# DOOR OPEN ERROR

Ticket Monster is equipped with safety switches inside every door.

If a door is open, the wheel will not engage and the motor will not spin the wheel.

An error will appear on the monitor if the game reads that a door is open.

The safety switches have 3 positions, and can be pulled out to simulate a closed door.

We don't recommend doing this unless it is necessary for testing purposes.

The switches are in place to prevent injury and should be used appropriately at all times.

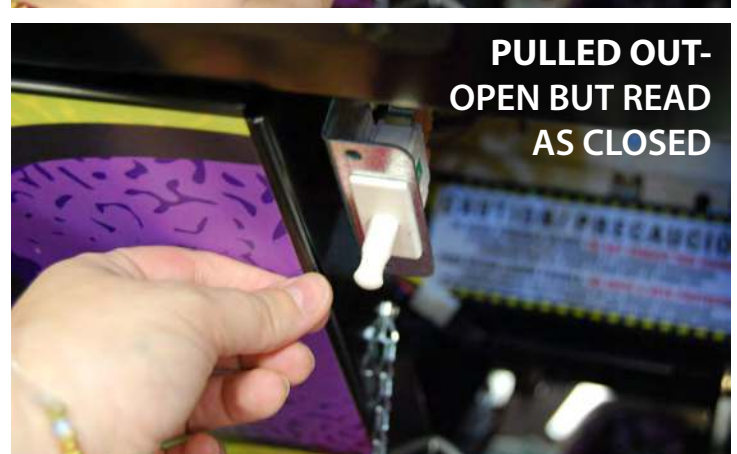
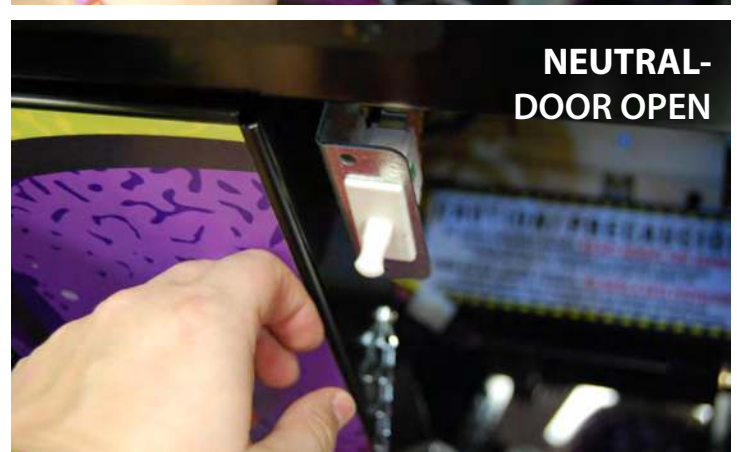

# PUPPY VIDEO WIZARD ERROR

If the monitor has been replaced or reset, a Puppy Video Wizard will appear on the screen at power up. The settings will have to be reset and saved before the game can be played.

Puppy Video Wizard screen will appear.

Open the front door of the cabinet and plug a PS/2 keyboard into the purple port on the motherboard.

Hit < ENTER >.

Make sure a resolution of **1024 x 768 x16** is selected, then hit < ENTER >.

The game software should now boot. Wait 10 secnds, then press < Q > on the keyboard.

Once the black screen with white and red code appears, type REBOOT and hit < ENTER >.

The game will save the video settings and boot up normally.



# POWER SUPPLY DIAGNOSTICS

1.) Verify AC power to front of game.

Check power strip in bottom front of game for light ON inside rocker switch. If light is not ON, remove back panel of cabinet and check AC power in and Power Strip in that location.



2.) Check AC power connection to power supply.

3.) Ensure Power Supply switch is set to 115V (or 230V)  
(Some model power supplies may not have this)

4.) Ensure Power switch is on.

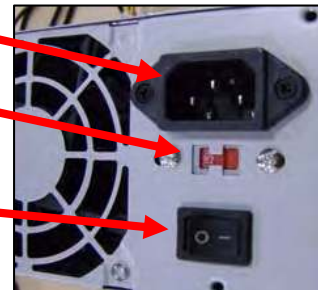

5.) Examine top left corner of motherboard. There is green LED ON.

**If LED is not ON, replace power supply. (AAPS4600)**

6.) Check connections from power supply.

Make sure these 2 connections are secure.

7.) **“Jump Start” Motherboard:**

If green LED is ON, but monitor is not ON, you may start motherboard by quickly touching these 2 red pins at the same time.

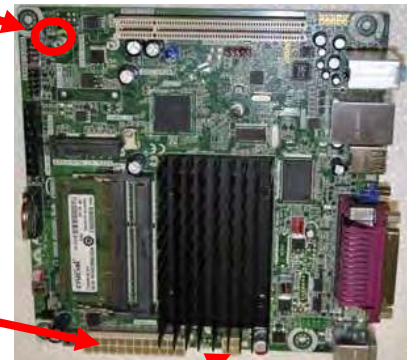

Large power supply connection

2 Black and 2 yellow wires  
(12 Volts DC)

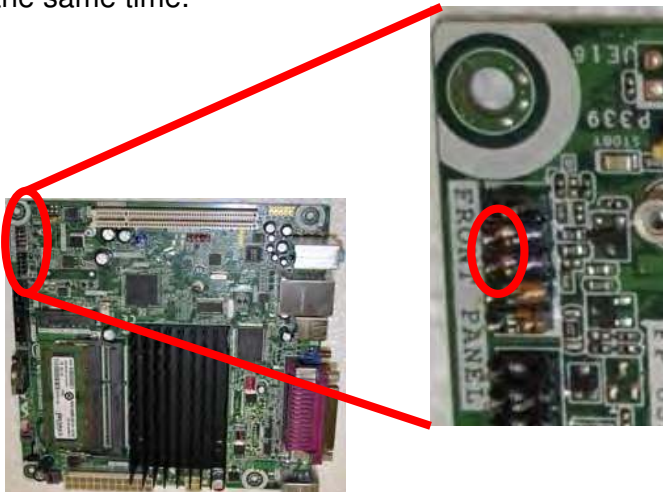

# TROUBLESHOOTING GUIDE

## Troubleshooting Strategy

Use a systematic method of troubleshooting to determine the exact problem, probable cause and remedy to your specific problem.

Use the process of elimination to identify the faulty component.

Always check for the simple and obvious solutions first, such as unplugged cables, loose or broken wires, bad sensors, and components that are bent, stuck, pinched or jammed.

PROBLEM	PROBABLE CAUSE	REMEDY
No power to the game No lights on at all	Game is unplugged	Check the wall outlet
	Circuit breaker tripped	Reset the power strip breaker switch or building circuit breaker
	Faulty power strip	Change the plug position, replace power strip if needed
	Faulty cable/ power supply	See "power supply diagnostic" on page 21
No audio	Volume set too low	Adjust the volume in the main menu
	Loose wire/ speaker unplugged	Check the audio cable (AACEAU010) connections from the I/O board to the motherboard to the speakers
	Faulty I/O board	Replace the I/O board (AACB1900)
	Faulty motherboard	Replace the motherboard (AAMB8)

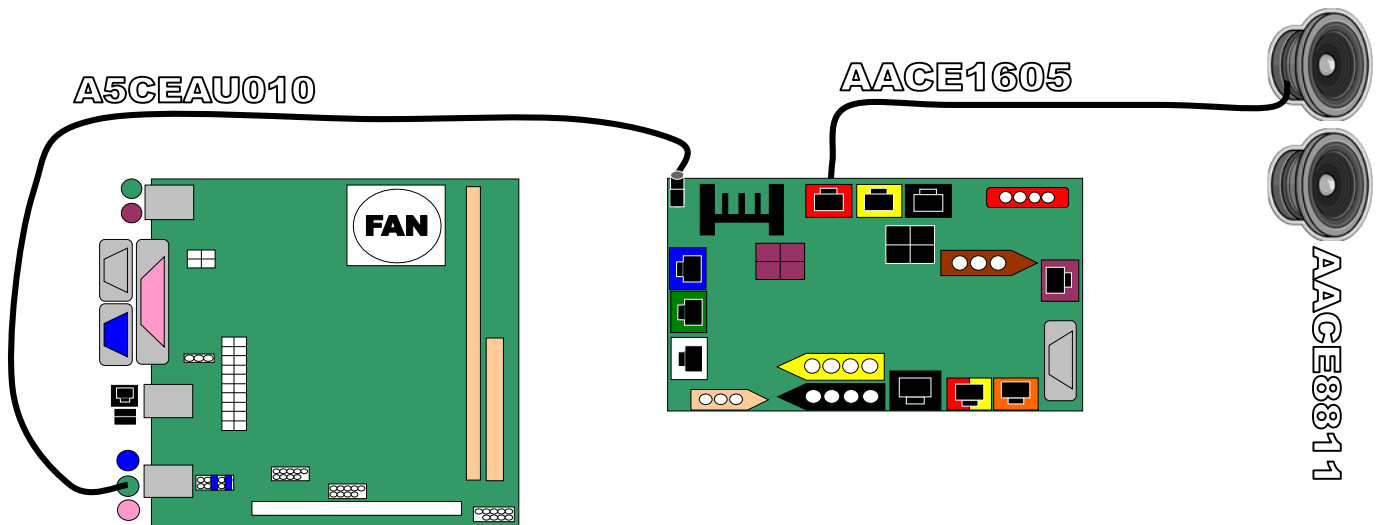

# TROUBLESHOOTING GUIDE

PROBLEM		PROBABLE CAUSE	REMEDY
Wheel lights not working	Both sides are out	Cable problem	Check the connections from the jumper cable (AACE1620) to the power supply
		Large POWER IN cable connection with motherboard is loose	Reseat connector
		Faulty power supply	See "power supply diagnostics" on page 21
	One side is out	Cable problem	Check the cables from the light strip (AACE1622) to the jumper cable (AACE1620) to the power supply.
		Faulty light strip	Replace light strip (AACE1622)
	Some lights are out	Faulty light strip	Replace light strip (AACE1622)
Dollar bill acceptor not working		DBA not getting 110 VAC	Acceptor should cycle at power up. If not, check the cable connections to the power strip. <b>CAUTION: 110 VAC</b>
		Dirt or debris in acceptor slot	Run a cleaning card (A5CC9000) through the acceptor
		Dips set wrong	The dips on the acceptor should be set to "always enable"
		Pinched, broken or disconnected wires	Check wiring from DBA to I/O board. Repair or replace wire (AACE1611)
		DBA problems	Refer to DBA manual

AACB1900  
I/O BOARD

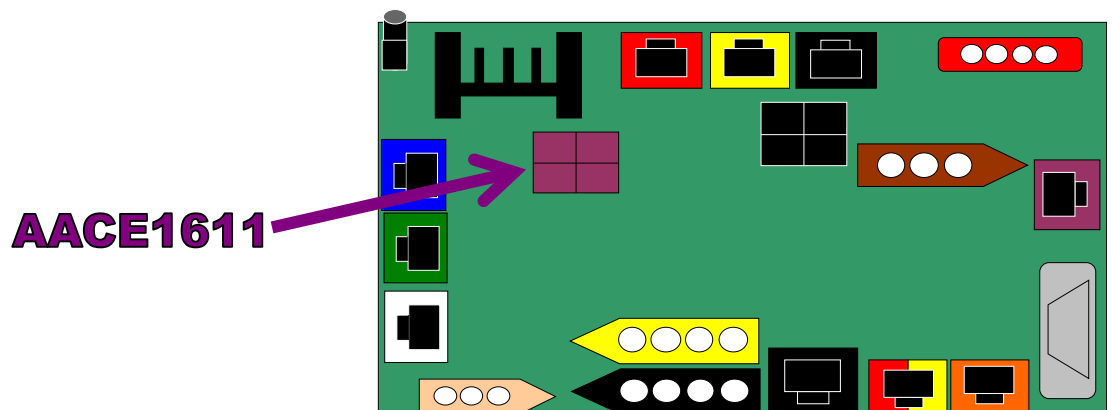

# TROUBLESHOOTING GUIDE

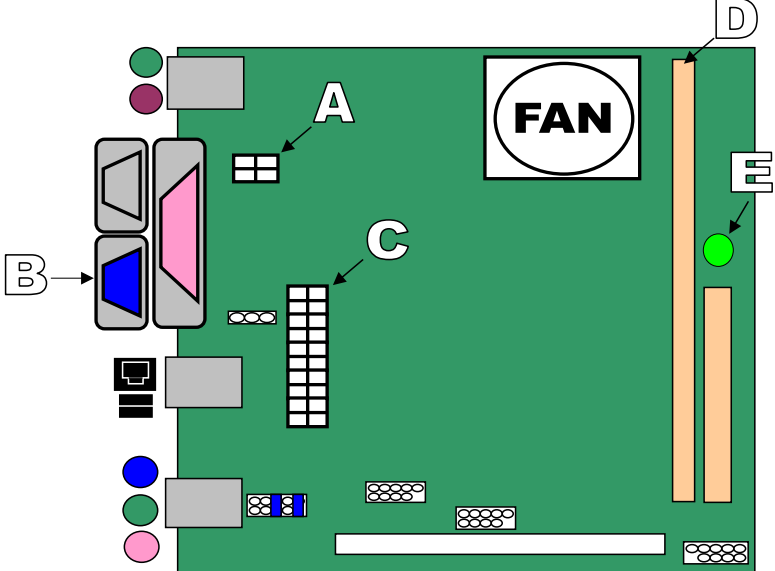
PROBLEM	PROBABLE CAUSE	REMEDY	
<p>Monitor not working</p> <p><b>First:</b> Power down, wait 10 seconds, then power up again</p>	<p>Shows "no signal" for 5 seconds, then goes dark</p>	12 volt power connector unplugged on motherboard (A)	Reseat connector
		Monitor VGA cable unplugged (B)	Reseat connector
		Large power connector unplugged on motherboard (C)	Reseat connector
		Faulty/loose RAM (D)	Reinsert RAM stick
		Faulty power supply (E)	See "power supply diagnostics" on page 21
		Faulty motherboard	Replace motherboard (A5MB8)
			
	Black screen	Power cable unplugged from monitor	Ensure the monitor power cable is securely seated into the monitor and power strip
		Faulty monitor	Replace monitor (A5DBDI030)
	<p>Error on screen</p> <p>(reboot to see if problem persists)</p>	Display shows "no bootable device- insert boot disk and press any key"	USB software flash drive loose, missing, or faulty
Display shows "puppy video wizard" or "Xorg"		Game is not recognizing monitor. Ensure VGA cable is secure to the I/O board or replace monitor.	
Display shows "kernel panic- unable to mount root"		Faulty or loose RAM	

# TROUBLESHOOTING GUIDE

PROBLEM	PROBABLE CAUSE	REMEDY
Monitor issues; Too bright, too dim, blurry, etc.	Monitor settings out of adjustment	Remove fish head
		Remove wood blocks holding monitor in place
		Take the monitor out of the wood frame
		Use buttons to adjust settings
Game plays, but not all the functions work	Inputs not working; no coin-up, buttons don't work, display reads "door open"	I/O serial cable unplugged between I/O and motherboard
	Display does not show some screens, no audio	USB software flash drive loose or faulty
	Game freezes or locks up	Faulty RAM or motherboard
Game doesn't coin up	One of the coin switches is jammed	Un-jam coin switch. If one is closed, the other won't work either.
	Short in coin door harness	Unplug red spade connector from door and jump between white and black wires to simulate coin up; replace harness if needed
	I/O serial cable unplugged between I/O and motherboard	Check connections and reseat cables; replace I/O serial cable if needed
	Faulty I/O board	Replace I/O board (AACB1900)
"Low tickets" displayed on monitor, despite being filled	Ticket stack not resting properly on the low ticket switches	Adjust ticket stack so it holds the switch down
	Faulty low ticket switch	Replace low ticket switch (A5SW200)
	Faulty wire or connection	Check the connection between the switch and the I/O board
	Faulty I/O board	Replace I/O board (AACB1900)

# TROUBLESHOOTING GUIDE

PROBLEM	PROBABLE CAUSE	REMEDY
<p>Motor does not engage to assist a slow spin.</p> <p><i>This does not apply to Washington State games</i></p>	Game set to “abandon game” under the player timeout option in the game menu	Change setting to “motor assist”
	Game displaying “motor watchdog error” in the diagnostics	Change setting to “motor assist”, power down for 10 seconds and restart to clear the error
	Door open	Motor will not engage if the game thinks a door is open. Close all doors; check door switches if issue persists.
	Faulty encoder sensor	Motor assist will try for 2 seconds, not see the wheel, then deactivate. Troubleshoot encoder sensor and replace if necessary.
	Auto spin catch is broken	Inspect mechanism inside left side door. Replace spring if needed (A5SREX040).
	Drive chain broken	Inspect drive chain that powers the wheel; replace if needed (A5CH1003)
	Cable problem	Inspect and reseat cable from the motor to the I/O board.
	Faulty I/O board	Replace I/O board
	Game is in New Jersey mode	New Jersey law does not allow the game to spin for the player; call Bay Tek Service Dept. for assistance

## Wheel Motor Information

As the motor starts, 5 volts is present at the connector. As the wheel gains speed, this increases to 12 volts. Phone cable to I/O board is double-crimped in the housing for redundancy; motor will still work if one wire happens to fall out or break.

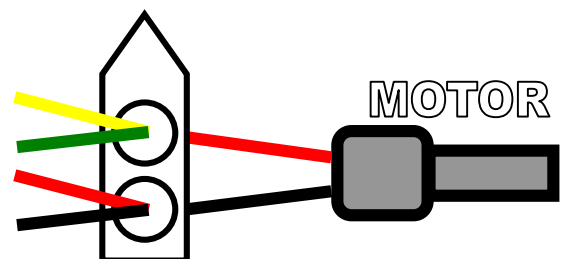

# TROUBLESHOOTING GUIDE

PROBLEM	PROBABLE CAUSE	REMEDY
Wheel spins continuously	Brake assembly is loose or broken	Adjust the brake or replace it
	Solenoid assembly is faulty or broken, causing the wheel to spin at any time	Replace the wheel engaging solenoid
	Spin motor reads 12 volts at all times; spin meter screen always on	Faulty I/O board, replace if needed
	Encoder sensor not seeing the wheel spin	Faulty or miscalibrated encoder sensor; calibrate or replace sensor
Spin meter does not read a good spin.	Encoder sensor dirty or faulty	Clean sensor; replace if necessary (AACB1901)
	Pinched, broken or disconnected wires	Inspect wiring and reseat or replace cable if needed (AACE1608)
	Faulty I/O board	Replace I/O board (AACB1900)
Wheel not spinning when the handle is pushed down.	Door is open	Wheel will not engage if the game thinks a door is open. Close all doors & inspect door switches; replace if needed
	Faulty solenoid assembly	Inspect the mechanism inside the right side access door for intact springs and engaging action. Replace assembly if needed (AASO4150).
	Cable problem	Inspect cable connecting the solenoid to the I/O board; replace if needed
	Faulty I/O board	Replace I/O board (AACB1900)

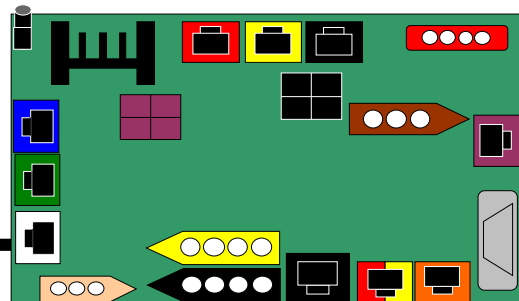

## Solenoid Information

The solenoid should output 12 VDC at game start. Phone cable is double crimped in housing for redundancy; solenoid should still work if one wire happens to fall out or break.

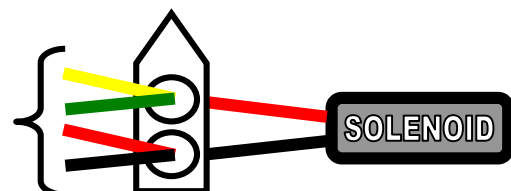

# TROUBLESHOOTING GUIDE

PROBLEM	PROBABLE CAUSE	REMEDY
<p>Solenoid is always on, allowing the wheel to spin at any time.</p> <p>During attract mode, a loud clicking sound occurs when the wheel spins.</p>	Jammed solenoid	Inspect solenoid to make sure it's working properly
	Missing or broken springs	Look for missing springs; replace assembly if needed (AASO1450)
	Pinched cable	Inspect phone cables; replace if needed
	Faulty I/O board	Replace I/O board (AACB1900)
<p>Analog game &amp; ticket counters do not work</p>	Cable unplugged	Check and reseat cable into I/O board
	Meters do not click as tickets are vended and games are played	Replace counters (AACO1000)
	Faulty I/O board	Replace I/O board (AACB1900)
<p>Monitor shows "Out of Order- Door Open"</p>	One or more doors is open	Make sure all doors are closed
	Faulty door switch	Check the limit switch inputs; replace switches if necessary (A5SW7000)
	I/O serial cable unplugged	Reseat the cable from the motherboard to the I/O board
	Faulty I/O board	Replace I/O board (A5CB1900)
<p>Motor watchdog error</p>	Faulty encoder sensor	Clean, calibrate or replace encoder sensor
	Faulty motor	Refer to page 29 for motor help
	<p>After a solution is found:</p> <p>Enter the main menu and make sure player timeout is set to "motor assist"</p> <p>Power down game and reboot, then coin up and allow the motor to spin the wheel</p> <p>Re-enter the menu and verify that "motor watchdog error" is no longer present.</p>	



# TROUBLESHOOTING GUIDE

	PROBABLE CAUSE	REMEDY
Game scores while wheel is still spinning	Weak encoder sensor	Replace encoder sensor (AACB1901)
Game dispenses tickets upon coin up	Brake too loose; game sees wheel spinning after coinup and scores as if it were played	Tighten the brake. See page 17
Game ends after a slow spin and gives no tickets	Motor assist not kicking in	Make sure player assist is not set to "abandon game". If correct, see page 29 to troubleshoot motor
Game reads incorrect ticket value  <i>Open menu and turn wheel downward; check ticket value display</i>	VALUES MATCH IN DIAGNOSTIC MENU	
	Motor watchdog error	See page 29
	Encoder sensor not reading properly	Clean, calibrate or replace sensor
	VALUES DO NOT MATCH IN DIAGNOSTIC MENU	
	Manually spin the wheel for one complete revolution so the home sensor can read. <b>Always spin the wheel downward.</b>	
	Encoder sensor not reaching I/O board	Check the cable between sensor and I/O board; reseat or replace if necessary
		Clean, calibrate or replace sensor
Replace I/O board		
Game pays out 10 or 75 tickets every game	Encoder sensor continually sees home position	Check green LED home indicators on sensor board; if always on as the wheel spins, replace the sensor
	Encoder signal not reaching I/O board	Check the cable between the sensor and the I/O board; reseat or replace if necessary
		Replace sensor or I/O board

# TROUBLESHOOTING GUIDE

PROBLEM	PROBABLE CAUSE	REMEDY
Tickets not dispensing from either of the two dispensers	Game is not registering a win	Winning value should be displayed on the monitor; see page 32 for encoder sensor troubleshooting
	Make sure the game is not reading an open door	Close all doors; inspect and replace door switches if necessary
	Faulty cables between I/O board and ticket dispensers	Inspect cables; reseat or replace if needed
	Faulty I/O board	Replace I/O board (AACB1900)
One ticket dispenser is working, while the other is not	Less than 5 tickets were won	No issue; less than 5 tickets will always vend from one dispenser only
	Faulty cable between I/O board and affected ticket dispenser	Inspect cable; reseat or replace if needed
	Faulty I/O board	Replace I/O board (AACB1900)
Wrong ticket amount dispensed	<b>GAME DISPLAYS DIFFERENT TICKET VALUE</b>	
	Incorrect ticket pattern selected	Verify the ticket pattern in the main menu
	Wheel position not read correctly	Clean, calibrate or replace encoder sensor
	<b>GAME DISPLAYS CORRECT TICKET VALUE</b>	
	Disconnected, loose or broken wires	Inspect cables; reseat or replace if necessary
	Ticket dispenser OPTO sensor dirty	Refer to blue Ticket Dispenser pages at the end of this manual; blow dust from OPTO sensor and wipe clean with isopropyl alcohol.
	Faulty ticket dispenser	Replace ticket dispenser
Notches between tickets are too small	Flip the ticket stack and load upside-down, causing the larger notches to align with the sensor.	



# TECHNICAL SUPPORT

Excellent customer service is very important to Bay Tek Games!

We know that keeping your games in great operating condition is important to your business. When you need us, we are here to help. You can call us for free technical assistance, and you can count on us to have parts on-hand to support your game. We offer options that fit your needs.

## Electronics / Circuit Boards - Repair Options

**Repair & Return** – If you have Circuit Board issues with your Bay Tek game, you can send the board to us and we'll repair it right away. Most items sent to us are repaired and returned to you within two days. This option is your best value as we offer this fast turn-around service at the most reasonable price.

**Advance Replacement** – If you have Circuit Board issues with your Bay Tek game, but you don't have time to send in your board in for repair, give us a call and ask for an Advance Replacement. We'll send you a replacement board that same day (pending availability). When you get your new board, just repackage the defective board in the same box and send it back to us. We make it easy by including a UPS Return Shipping label for you to put on the box (not available for international shipments). This is your best option when you need to get your game up and running as quickly as possible!

**Spare Parts** – Take matters into your own hands and purchase new spare Circuit Boards for your Bay Tek games. Many of our games share the same main-board electronics. This means you can buy one set of spare electronics to support many of your Bay Tek games. Spare boards allow you to get your game up and running the quickest and provide you a valuable troubleshooting option. Call our technicians to get recommendations for what you should keep on hand for spare parts!

## Technical Support:

"You" are the best tool for troubleshooting! Your abilities to understand the game and your skills to repair the game are invaluable to us! If you need help, you know you can call us. It's not easy to diagnose a game remotely by phone, but our technicians do a great job. They'll need your help to perform some troubleshooting steps and convey to them exactly what's happening with your game.

## Returns, Credits, & Fees:

**NOTICE!** ALL ITEMS being sent to Bay Tek Games for repair or return, etc. require prior Return Authorization! Bay Tek Games will provide a Product Return Form with an authorizing Ticket Number for each item to be returned. Please be certain to include this document with all shipments!

**Late Fees and Non-Return Fees** - Advance Replacement and Warranty Replacement items require the defective items to be returned by Bay Tek games promptly to avoid Late Fees. We expect items to be returned with 10 working days. Late fees are invoiced monthly. Late fees are non-refundable under any circumstance! Any item not returned within 90 days will be invoiced in full as a replacement part.

**Bench Fees** - Bench fees will apply for each electronic item returned to Bay Tek Games (this includes unused Advance Replacement items). This charge covers our cost to inspect, evaluate and retest each item. Please note that returned items that do not pass our tests will be charged accordingly as replacement items or advance replacements.

**Restocking Fees** - Unused items returned for credit will be credited minus a restocking fee. Items must be returned within 30 days of purchase in order to qualify for any credit amount. No shipping charges will be credited.

# WARRANTY

Bay Tek Games warrants to the original purchaser that all component parts will be free of defects in workmanship and materials for a period of 6 months from the date of purchase. An additional 3 month warranty extension can be obtained by filling out and submitting the Warranty Registration for each machine. Warranty Registration cards may be found as shipped with each machine or online at our website. These must be filled out and submitted to Bay Tek Games within 30 days of purchase to be valid.

For any game/machine we manufacture that is within its warranty period, with notification to our Parts & Service Department, Bay Tek Games will, without charge, repair or replace defective component parts. It is the owner's responsibility to diagnose, remove and replace any faulty component part at their own expense & peril. As needed, at no charge, Bay Tek Games can provide reasonable telephone technical support during our normal business hours.

All claims of defective parts are subject to review upon our inspection of the faulty item. This warranty does not apply in the event of any misuse or abuse to the product, or as a result of any unauthorized repairs or alterations. The warranty does not apply if any serial number decal is altered, replaced or removed from its original position.

To process warranty replacement claims, customers may be charged for the replacement item at the time of shipment and later credited the same amount when the faulty item is returned and has passed our inspection. Bay Tek Games will provide the customer a pre-paid return shipping label which is sent along with the replacement item. The customer is responsible for properly packaging and shipping the faulty item back to Bay Tek Games.

	<b>ATTENTION</b>	
<p>In order to maintain the safety &amp; compliance certifications of this game, <b>ONLY</b> approved parts may be used. For approved replacement parts, refer to the parts list in this manual.</p>		

Should you need your game serviced, determine the serial number from the decal placed on the front of this manual, or locate it on the back of the game. Then contact our Service Department at: 920.822.3951 or e-mail: [service@baytekgames.com](mailto:service@baytekgames.com)

# NON-WARRANTY

Options and estimated charges will be provided to you for your approval.

Please remember that any items being sent to Bay Tek Games must include prior return authorization from our Parts & Service Department.

This approval will include a Product Return Form which is required to be included with any incoming shipments. Repaired parts will be shipped back using the same method in which they were received.

Repairs are warranted for 30 days from the date of return shipment.

# CERTIFICATE OF COMPLIANCE

COMPLIANCE CERTIFICATION TESTING IN PROGRESS