KALKOMAT

BOXER

Punch-Force measuring machine

Technical Information



Index:

1. Introduction	3
2. Usage/Purpose	3
3. Technical Data.....	4
4. Assembly/ Construction description.....	4
5. Transport.....	6
6. Installation	6
7. Usage instructions	7
8. Maintenance check list, problem prevention and day-to-day conservation	8
9. Quick check for potential errors	12
10. Machine setup.....	16
11. Spare parts and equipment.....	42
12. Standard replacement parts.....	42
13. Required tools and equipment for servicing the boxing game	42
14. Step by step setup and maintenance instructions.....	44

1. Introduction

Main purpose of this Technical Information is to:

- familiarize user with machine construction,
- provide proper setup parameters, installation and power line hookup,
- familiarize user with proper and safe usage procedures, exploitation and conservation.

WARNING! USER MUST FOLLOW ALL GUIDELINES INCLUDED IN THIS DOCUMENT FOR SAFE AND LONG LASTING MACHINE USAGE.

2. Usage/Purpose

Boxer – punch-force measuring machine comes in several different models:

- **GLOVE**
- **WHEEL OF BOXING**
- **MASK**
- **DYNAMIC**
- **SPIDER**
- **FIRE**
- **WIN CASH**
- **SEXER**

Each model has three settings to compute punch force, punch speed and reflex.

Boxers can be placed in night clubs, gyms, bars etc., generating tons of positive fun and allowing players to check/measure their boxing skills (punch force, punch speed, reflex). Complete and detailed usage instructions are under paragraph 7 of this document and on the sticker placed on each machine.

3. Technical Data

Model	GLOVE	SPIDER	MASK	FIRE	WOB WINCASH DYNAMIC SEXER
Depth [in]	53	45	51	49	51
Width [in]	22	25	28	28	28
Height [in]	88	85	102	84	85
Overall Mass [Lb]	331	254	276	276	276
Power consumption [Wh]	200	180	210	180	200

4. Assembly/ Construction description

Punch-force measuring machine Boxer is built out of three main components:

- base,
- middle assembly,
- top assembly.

The key component is a mother board (electronic board) placed inside Boxer's body (block schematics drawing# 1) to which mechanical elements and user interface components are connected.

Electric/ electronic part contains following:

- power supply (drawing# 4) – consists of transformer, fuses and broadcasters that control alarm sirens & electromagnet – transforms voltage from 110 V to 12 V (connected to main board J6),
- measuring mechanism – consists of sending and receiving diodes that measure blade fly speed through assembly,
- verbal information mechanism – built using potentiometer and speaker, used to send voice messages,
- punching bag lowering mechanism – consists of button START with backlight and electromagnets – actual lowering mechanism,
- visual information assembly – assembled out of diodes used for visual representation of punch force measurement, warning siren (informs player of breaking top record) also displays on electronic panel (shows measurement result, credit amount, top day record),

- coin acceptor – used to deposit coins (can be reprogrammed to tokens or other currencies),
- bill acceptor – used to deposit bills,
- mother board.

5. Transport

Machine should be transported in vertical position. Machines are shipped on a wooden 41" x 53" pallet, and sides are covered with special thick (~3/8") multi-layer cardboard 93" tall (from the bottom of the pallet). The total weight of the box is approx. 491 lbs.

After machine is taken out of the box, it should be transported in horizontal position with the help of two wheels. Machine can, in special cases (exp. if it does not fit in doorway), be taken apart and then reassembled. This procedure should be done by a specialist or someone familiar with all technical information.

6. Installation

Machine, after being taken out of the box, should be placed in vertical position and the base should be leveled. To level the machine correct tools should be used (exp. laser level or typical manual construction heavy duty level). Turning several screws under the base allows for level adjustment. After plugging the machine to power outlet it should be ready to use.

Make sure that there is enough clearance on the sides and in front of the machine, so the player will not hit any objects after

punching the bag. The **installer** of the machine is responsible for defining the safe clearance.

7. Usage instructions

- a) Select type of game (default setting is power mode) by pressing SELECT GAME button located on the main body of

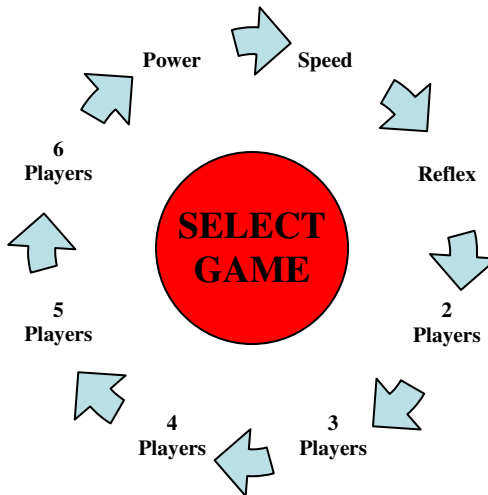

the game. Player can choose between following types of game: power, speed, reflex and tournament for up to six players. Pressing the SELECT GAME button will cycle through the available modes as illustrated in the diagram above. In the 2 to 6 players tournament mode machine measures the player's power.

- b) Before pressing the START button player must stand in front of the Boxer.

- c) After pressing the START button player has to wait in front of the machine for the punching bag to be released from the upper position.
- d) After the punching bag is released, player should make a fist so the thumb would be on the outside of the pointing and the middle finger.
- e) The punch must be placed in the center of the punching bag.
- f) After the punch, a score would be displayed on the front panel.
- g) Follow the same instructions before the next game.

8. Maintenance check list, problem prevention and day-to-day conservation

Every two weeks (recommended):

- check the air pressure of the bag - it should be **NO MORE** than 2psi,
- check if the bag is not rotating about its own axis. If it is, see point D in this section,
- check the position of the arm protector (see point H in this section),
- check all of the connections on the main board,
- check the level/ balance of the machine (if needed, use adjusting legs under the machine to bring the machine to

level),

- check if the usage instructions are readable.

Every month:

- check mounting cover screws/nuts,
- check the lubrication of the mechanism (for instructions see point C in this section),
- check the display lights,
- clean the bill acceptor.

A) Coin acceptor maintenance

Coin acceptor should be cleaned periodically (every 2000 - 3000 credits). Best way to clean it is by using simple cloth slightly soaked in distilled alcohol. Focus should be placed on cleaning the area where coins slide through (make sure sliding part is in open position).

B) Sound volume regulation

R362 potentiometer (see drawing#1) used to control volume is placed on the right side of the electronic board. The volume adjustment can be done by rotating the potentiometer to the left or right.

C) Maintenance of mechanism and regulating spring

Periodically (once a month or more often, or if the lowering speed of punching bag is fairly low) all moving elements should be

rubbed/ sprayed with WD-40 or grease.

If punching bag lowers slowly or too fast one should check if spring is properly stretched. Spring can be adjusted with screw that is in the front left side after taking the masking net.

In case of forced lowering mechanism replacement one should unscrew plastic casing, and then take off masking board (black from the bottom) and remember about the retro cop light.

D) Manual punching bag reposition

In case the punching bag is vibrating too much (or if it is rotating around its own axis), the top nut located on the punching bag screw should be tightened (loosen the lower nut first) until the bag is not rotating any more.

E) Replacement of inner punch bag bladder

To replace inner bladder of the punch bag one should untie rope, take out old insert and replace it with a new rubber bladder. A special attention must be paid to the location of the bladder valve. The valve must be placed in the opening of the leather cover.

F) Bulb replacement, GAME button

In case of bulb failure in the GAME button one should take out micro-switch from the casing (by slight turn and then pull) and then proceed with bulb replacement [bulb spec: 12 Volt & 3 Watt].

G) Fuse replacement

Machine is equipped with two long term fuses. One at power supply assembly and the second one on the main electronic board [specs: 250V & 4 A]. In case of short circuit situation and/or insufficient power supplied to the electronic main board one should first check the fuses and if they are burned, then proceed with replacement. Make sure fuses used to replace old one have the same specifications.

H) Position of the Arm protector

DO NOT PLAY THE GAME WITHOUT PROPERLY PLACED ARM PROTECTOR.

The position of the arm protector should be like on the picture below:



The following two pictures illustrate an improper setup of the punching bag. NEVER leave the machine in this state. The

picture on the left shows the arm protector placed too high. The second picture shows the missing arm protector. Both of these cases may result in serious injury to the user.

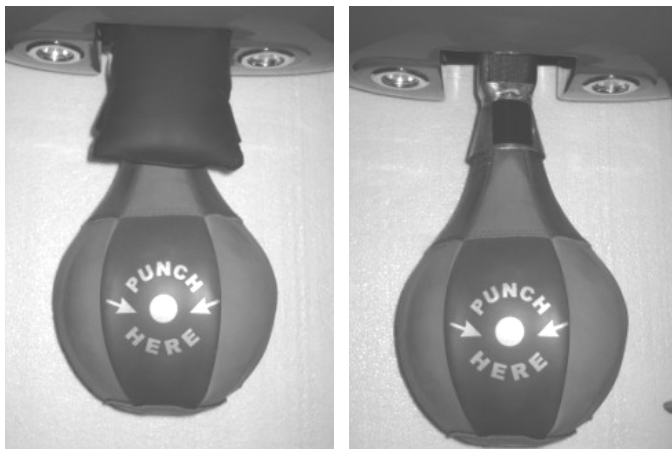

9. Quick check for potential errors

Main board not functioning:

- 1 Check all fuses (5A).
- 2 Check the connection between power supply and the main board.
- 3 Make sure that the main processor and other connectors are well seated.
- 4 The main display can be checked by turning the switch #1 to “ON” position than turning machine off and back on.

Coin Acceptor is not functioning:

- 1 Check if it is not clogged up.
- 2 Check for dust and dirt.
- 3 Check strip connecting the main board with the acceptor.

Mechanism is not functioning:

- 1 Using just power supply check if it is possible to lower punching bag (using manual switch, black button above the 12V connector - see drawing #3).
- 2 Check for burned fuse 30A.
- 3 Check button functionality and if they have proper connection.
- 4 Check for unhooked cable from power supply spools.
- 5 Check strip connecting the main board with the power supply.

Sensor is not functioning:

- 1 Check sensors in service mode (using switch 1 on main board (S1) and manipulating button SW1 go to mode P07), if punching bag is moving UP/DOWN and on the main board (depending on bag position) HI – LO shows this would indicate that sensor is working.
- 2 Check if sensor cable is firmly connected to the main board.
- 3 Check all wires to/from the sensor.

Halogen lights are not functioning:

- 1 Check power supply cable connection.
- 2 Check power supply wire integrity.
- 3 Check connector plug for loose bulb.
- 4 Check if halogen is not burned by swapping it with a new one (12V 20W).

Button START or GAME is not functioning:

- 1 Check for main board cable connection.
- 2 Check switch/button cable connection.

Computer power supply is not functioning:

- 1 Check if power supply cable is plugged in securely.

Power supply is refusing to work:

- 1 Check if “car” fuse in power supply is not burned (30A).
- 2 Check if transformer cable is correctly hooked up to power supply socket.

Machine is not starting:

- 1 Check power cable fuse 5A.
- 2 Check if ON/OFF switch (filter) is not damaged.

Counter is showing Err:

- 1 Check if mechanical counter did not come loose (then turn the machine OFF and ON).

Bill Acceptor is not functioning:

- 1 Check if power supply cable is hooked up to main board (J3).
- 2 Check if cable from bill acceptor is correctly hooked up.
- 3 Check acceptor settings using switches: for switches 1-8 set 7 at ON, and for switches 1-4 set 3 & 4 at ON.

Sound is not working:

- 1 Check if it is not at low volume or mute (R362).
- 2 Check if cable is correctly connected to the main board.
- 3 Check if cable to speaker is correctly connected.

Red diode active on main board:

- 1 Usually caused by circuit being shorted at scale bulb array, check all cables for potential shortage.

10. Machine setup

Main Board Layout (Back Side)

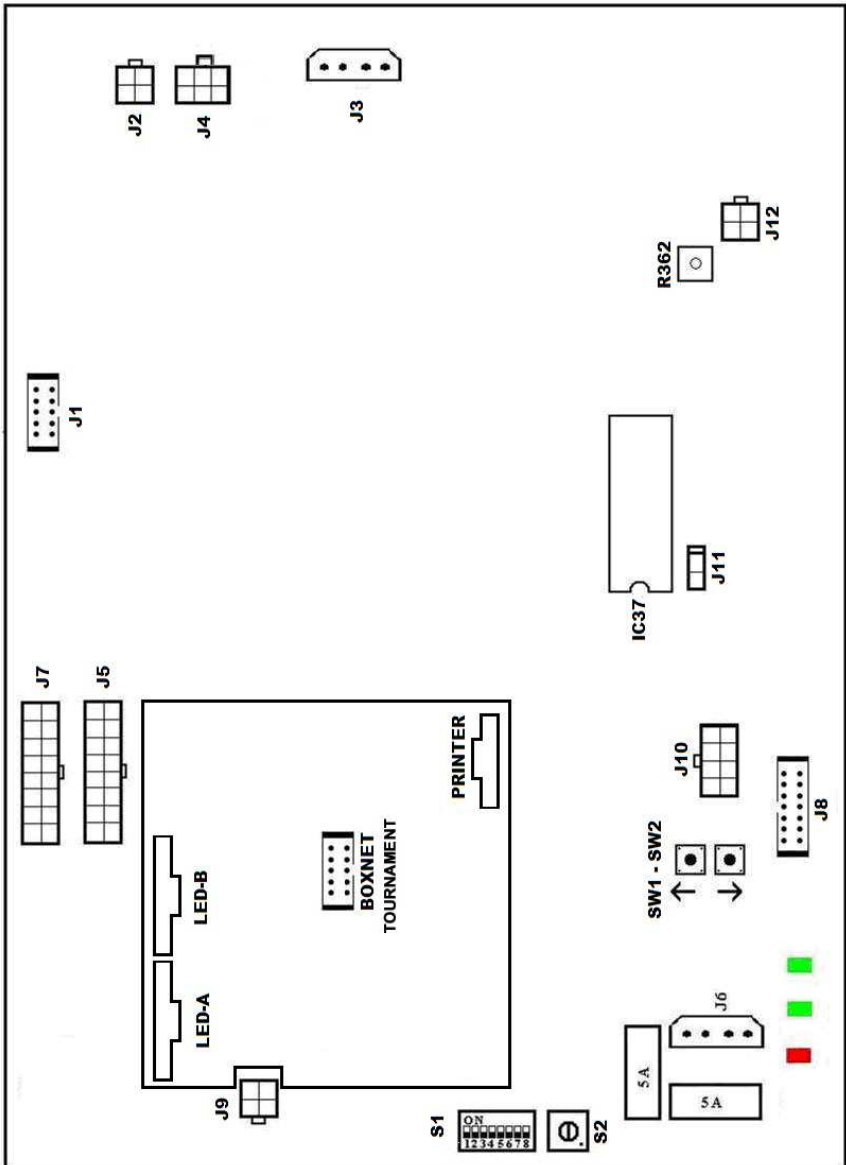

Drawing #1

List of connectors:

- J1 – connector for coin acceptor**
- J2 – connector for bill acceptor**
- J3 – connector for power supply to bill acceptor, ticket dispenser, capsule dispenser, thermal printer**
- J4 - connector for ticket dispenser, capsule dispenser, thermal printer**
- J7 & J5 – front panel backlight**
- J6 – connector for main board power supply (12V supplied by AC power supply)**
- J8 – connector for power supply**
- J9 – sensor connector**
- J10 – connector for buttons GAME and START**
- J11 – connector for mechanical counter**
- J12 – connector for speaker**
- S1 – service setting switches**
- S2 – step potentiometer for setting sensor sensitivity (0 – min, 9 - max)**
- SW1 & SW2 – help buttons (up/down)**
- R362 – potentiometer for volume control**
- IC37 – speech synthesizer**
- IC34 – main processor socket**
- LED-A and LED-B - connector for wheel LEDs**
- PRINTER - connector for thermal printer**
- BOXNET/ TOURNAMENT - connector for BoxNet or BoxTournament for PC**

Dip Switch 1-8 (S1)

THE RED (BLACK OR BLUE) SWITCH BOX WITH 8 SWITCHES IS LOCATED ON THE LEFT SIDE OF THE MAIN CIRCUIT BOARD. TO PROGRAM, SWITCH #1 MUST BE SET TO "ON" POSITION WHEN MACHINE IS "ON".

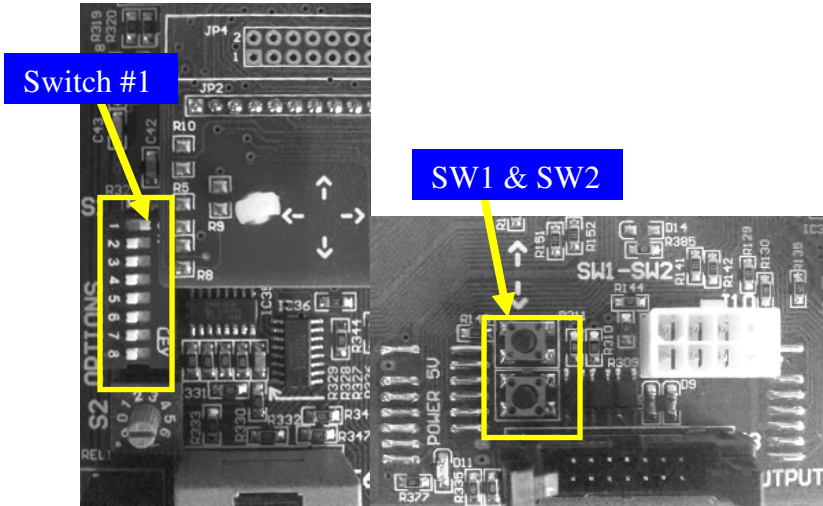

PUSH BUTTONS SW1 ↑ AND SW2 ↓ ARE LOCATED IN THE LOWER LEFT PART OF THE MAIN CIRCUIT BOARD.

Switch #1

THIS SWITCH IS USED TO ENTER THE PROGRAM SETTINGS. PLEASE USE BUTTONS SW1 ↑ OR SW2 ↓ FOR FINDING THE RIGHT PROGRAM P01-P89. DESCRIPTIONS FOR EACH PROGRAM ARE LISTED BELOW. DURING PROGRAM SELECTION YOU WILL SEE P01-P89 ON THE MAIN DISPLAY.

REMEMBER, FOR SOME SETTINGS YOU WILL USE "START" OR "SELECT GAME" BUTTONS.

P01

TEMPORARY COUNTER OF POINTS. **1 POINT = \$.25 (25 CENTS).**

YOU CAN RESET IT TO 0000 BY PUSHING AND HOLDING THE "START" BUTTON FOR 3 SECONDS.

P02

COUNTER OF POINTS. THIS IS LIFE LONG - NOT ERASEABLE.

P03

ELECTRONIC COUNTER OF REVENUE (COUNTS THE QUOTERS WHILE THE MECHANICAL COUNTER IS DISCONNECTED).

P04

CREDIT RATIO. HOW MANY QUARTERS (\$.25) IS NEEDED FOR 1 CREDIT.

THE LEFT SIDE OF THE RATIO IS CONTROLLED BY THE "START" BUTTON.

Example: 1 credit is worth four quarters (\$1), so the P04 will be set to 4 - 1.

1 credit is worth two quarters (50 cents), so the P04 will be set to 2 - 1.

NOTE: IF THE BILL ACCEPTOR IS SET 4 PULSES FOR A 1\$, SET P09 TO 12 (in case of the older software to 5).

P05

YOU CAN SET ADDITIONAL CREDITS (BONUS CREDITS) WHEN A SET DOLLAR AMOUNT IS INSERTED. USING THE "START" BUTTON YOU CAN ADJUST HOW MANY QUARTERS RECEIVED AT ONCE WILL GIVE THE BONUS. USING THE "SELECT GAME" BUTTON YOU WILL THEN ASSIGN NUMBER OF CREDITS FOR THE RECEIVED AMOUNT.

Example: you want to set 8 credits (punches) for \$5, you should set P05 to 20-8. **NOTE: SEE SETTING P65.**

P06

THIS SETTING FUNCTIONS THE SAME AS P05 **BUT ALWAYS FOR BIGGER VALUE OF THE BILL OR COIN THAN P05.**

Example: if you want to set 8 credits (punches) for \$5, you should set P05 to 20-8.

if you want to set 18 credits (punches) for \$10, you should set P06 to 40-18. **NOTE: SEE SETTING P65.**

P07

THIS FUNCTION IS USED FOR TESTING OF THE SENSOR (DIAGNOSTIC FUNCTION).

WHEN PUNCHING BAG IS IN THE VERTICAL POSITION - THE DISPLAY SHOWS - "LO", WHEN PUNCHING BAG IS IN THE HORIZONTAL POSITION - DISPLAY SHOWS "HI".

P08

YOU CAN SET THE BEST SCORE WHICH WILL BE ON THE DISPLAY FOR **POWER** MODE ONLY. PLAYERS WILL NEVER BE ABLE TO RECEIVE A HIGHER SCORE (WHICH MUST BE SET BETWEEN **900** AND **990**). YOU CAN ADJUST THIS VALUE BY USING "START" (UP) AND "SELECT GAME" (DOWN) BUTTONS. AFTER YOU SET THE DESIRED UNATTAINABLE POWER HIGHEST SCORE YOU MUST TURN **SWITCH # 5** TO "ON" POSITION.

IMPORTANT: AFTER YOU SET THE RECORD AND PUT SWITCH #5 TO "ON" POSITION YOU MUST TURN OFF THE MACHINE FOR 5 SECONDS.

P09

THIS FUNCTION IS USED FOR DIFFERENT SETTINGS OF THE COIN ACCEPTOR, FOR EXAMPLE: 0-USA, 1-CANADA.

NOTE: IF THE BILL ACCEPTOR IS SET 4 PULSES FOR A 1\$, SET P09 TO 12 (in case of the older software to 5).

P10

PARAMETER USED BY FACTORY. DEFAULT SETTING IS 0.

P11

HOPPER OUTPUT DEVICE SETTING

0 - OFF,

1 - TICKET DISPENSER,

2 - BALL DISPENSER,

3 - POWER ALWAYS ON (USED FOR THERMAL PRINTERS).

NOTE: IN ORDER TO MANUALLY FEED THE TICKET DISPENSER PRESS AND HOLD IN THE SAME TIME SWITCH SW1 AND SW2.

DEFAULT SETTING IS 3.

P12

SETS HOW MANY TICKETS WILL BE GIVEN FOR 1 CREDIT (RANGE FROM 0-5, DEFAULT SETTING 5).

P13

SETS HOW MANY TICKETS FOR THE HIGHEST SCORE (RANGE FROM 0-20, DEFAULT SETTING 5).

P14

“BREAKING POINT”- BP.

SETTING THAT WOULD ENABLE THE TICKET DISPENSER TO START GIVING OUT THE TICKETS (RANGE FROM 0-990). FACTORY SETTING IS 0.

P15

SETS HOW MANY TICKETS WILL BE GIVEN OUT AFTER REACHING THE “BREAKING POINT” AS THE FIRST VALUE (RANGE FROM 0-20). FACTORY SETTING 0.

P16

POINT INCREMENT, IN ANOTHER WORDS - HOW MANY MORE POINTS MUST BE SCORED BEFORE THE NEXT TICKET/S WILL BE GIVEN OUT (RANGE FROM 10-100). FACTORY SETTING 40.

P17

NUMBER OF TICKETS GIVEN OUT AFTER REACHING EACH POINT INCREMENT – SET IN P16. RANGE 0-5, FACTORY SETTING 0.

P18

COUNTER OF RELEASED TICKETS.

BELOW 2 EXAMPLES.

RESULT ON DISPLAY	TICKETS	RESULT ON DISPLAY	TICKETS
0	0	0	0
40	1	40	0
80	2	80	0
120	3	120	0
160	4	160	0
200	5	200	0
240	6	240	0
280	7	280	0
320	8	320	0
360	9	360	0
400	10	400	0
440	11	440	0
480	12	480	0
520	13	520	0
560	14	560	0
600	15	600	10
640	16	640	12
680	17	680	14
720	18	720	16
760	19	760	18
800	20	800	20
840	21	840	22
880	22	880	24
920	23	920	26
960	24	960	28
P14 = TICKET = 0		P14 = TICKET = 600	
P15 = TICKET= 0		P15 = TICKET = 10	
P16 = TICKET=40		P16 = TICKET = 40	
P17 = TICKET= 1		P17 = TICKET = 2	

P19

YOU CAN SET 0-10 BONUS CREDITS FOR BREAKING RECORD (HIGH SCORING IN POWER MODE) (USE THE “START” BUTTON). DEFAULT SETTING IS 1.

P20

YOU CAN CLEAR THE CREDITS BY PUSHING THE “START” BUTTON.

P21

COUNTER OF FREE PUNCHES WHICH YOU ACTIVATE BY PUTTING DIP SWITCH # 2 TO “ON” POSITION.

P22

COUNTER OF THE BROKEN RECORDS (HIGHEST SCORES) (CAN BE RESET BY PRESSING & HOLDING “START” BUTTON).

P23

WHEEL OF FUN MODE SETTINGS.

0 - THIS SETTING DISABLES THE WHEEL OF FUN OPTION. ONLY TWO WINNING PRIZES ARE POSSIBLE.

PRIZE #1 is for triple numbers such as 111, 222, 333...999.

PRIZE #2 is for multiples of 100 such as 100, 200, 300...900.

Note: Setting prize #3 is available in this mode but does not have any meaning and is reserved for future expansions.

1 – WHEEL OF FUN IS ENABLED. THREE WINNING PRIZES ARE SET FOR THIS MODE. EACH PRIZE CORRESPONDS TO ITS ASSIGNED POSITION ON THE WHEEL.

Example: Position on top of the wheel, usually with a blue light, is decorated with a numbered sticker (Prize #3).

Prize #3 is awarded when the game stops at this position.

2 – FORTUNE FUN IS ENABLED. FREQUENCY OF WINNING IS SET IN P58. ALSO P46-48 MUST BE SET.

3 – IN THIS MODE WINNING IS BASED ON A RANGE OF NUMBERS. P59 TO P64 MUST BE SET.

Example: Prize #1 is won when the score falls between the two numbers set in P59 and P60. Factory default setting for prize #1 is between 900 and 950.

NOTE: The machines without mounted “Wheel of Boxing” have possibility of giving out Prize #1 and #2 based on the scored number. Prize #1 is for triple number like 111, 222, 333 etc. Prize #2 is for multiples of 100, like 100, 200, 300 etc. In order to have a prove of winning the prize, thermal printer, ticket dispenser or capsule dispenser is recommended. The machine will print ticket for the highest score (Power mode) as a Prize #4 if printer is installed.

	P24	P25	P26
IF P23 = 0	Set	Set	Don't Set
IF P23 = 1	Set	Set	Set
IF P23 = 2	Don't Set	Don't Set	Don't Set
IF P23 = 3	Don't Set	Don't Set	Don't Set

P24

FREQUENCY OF WINNING - FOR PRIZE #1. THIS REPRESENTS THE NUMBER OF POINTS (QUARTERS) ACCUMULATED BEFORE THE POSSIBILITY OF WINNING THE PRIZE. REACHING THIS NUMBER DOES NOT GUARANTEE A WINNER, HOWEVER IT INCREASES THE CHANCES OF WINNING (RANGE 0-10000, DEFAULT SETTING 1200).

Example: If number is set to 100, for every 100 quarters (\$25) collected by the machine there will be one possibility of winning prize #1.

P25

FREQUENCY OF WINNING - FOR PRIZE #2. RANGE 0-10000, DEFAULT SETTING 800). SEE **P24**.

P26

FREQUENCY OF WINNING - FOR PRIZE #3. RANGE 0-10000, DEFAULT SETTING 8000. SEE **P24**.

P27

THIS COUNTER REPRESENTS THE NUMBER OF POINTS (QUARTERS) COLLECTED FOR POSSIBILITY OF WINNING PRIZE #1 (CAN BE RESET BY PRESSING & HOLDING START BUTTON).

P28

COUNTER FOR NUMBER OF COLLECTED POINTS (QUARTERS) TOWARDS PRIZE #2 (CAN BE RESET BY PRESSING & HOLDING START BUTTON). SEE **P27**.

P29

COUNTER FOR NUMBER OF COLLECTED POINTS (QUARTERS) TOWARDS PRIZE #3 (CAN BE RESET BY PRESSING & HOLDING START BUTTON). SEE **P27**.

P30

INITIAL HIGHEST SCORE (RECORD) SETTING FOR POWER PUNCH (RANGE 500-999, DEFAULT SETTING 650).

P31

NUMBER OF FREE CREDITS AWARDED FOR THE PRIZE #1 CAN BE ASSIGNED USING THIS OPTION. THIS NUMBER CAN BE SET IN THE RANGE OF **0-50**, DEFAULT SETTING: 1.

P32

NUMBER OF FREE CREDITS AWARDED FOR PRIZE #2 CAN BE ASSIGNED USING THIS OPTION. THIS NUMBER CAN BE SET IN THE RANGE OF **0-50**, DEFAULT SETTING: 1.

P33

NUMBER OF FREE CREDITS AWARDED FOR PRIZE #3 CAN BE ASSIGNED USING THIS OPTION. THIS NUMBER CAN BE SET IN THE RANGE OF **0-50**, DEFAULT SETTING: 1.

P34

NUMBER OF TICKETS GIVEN FOR PRIZE #1 CAN BE ASSIGNED USING THIS OPTION. THIS NUMBER CAN BE SET IN THE RANGE OF **0-50**, DEFAULT SETTING: 5.

P35

NUMBER OF TICKETS GIVEN FOR PRIZE #2 CAN BE ASSIGNED USING THIS OPTION. THIS NUMBER CAN BE SET IN THE RANGE OF **0-50**, DEFAULT SETTING: 10.

P36

NUMBER OF TICKETS GIVEN FOR PRIZE #3 CAN BE ASSIGNED USING THIS OPTION. THIS NUMBER CAN BE SET IN THE RANGE OF **0-50**, DEFAULT SETTING: 15.

P37

COUNTER SHOWING THE NUMBER OF PRIZE #1 WINNERS (CAN BE RESET BY PRESSING & HOLDING "START" BUTTON).

P38

COUNTER SHOWING THE NUMBER OF PRIZE #2 WINNERS (CAN BE RESET BY PRESSING & HOLDING "START" BUTTON).

P39

COUNTER SHOWING THE NUMBER OF PRIZE #3 WINNERS (CAN BE RESET BY PRESSING & HOLDING “START” BUTTON).

P40

SETTING OF THE LOWEST SCORE (BREAK POINT), FOR WHICH THE THERMAL PRINTER INSTALLED ON THE MACHINE WILL PRINT A TICKET (RANGE 100-999, DEFAULT SETTING 998). THE PRINTER SHOULD BE SET UP TO PRINT THE PLAYER’S SCORE.

NOTE: This print out has a delay of 20-30 seconds.

P41

IF SET TO ‘1’ THE TICKET FROM THE THERMAL PRINTER (IF INSTALLED) WILL BE PRINTED FOR THE HIGHEST SCORE (IN THE POWER MODE) – PRIZE #4.

IF SET TO ‘0’ NO TICKET FOR THE HIGHEST SCORE WILL BE PRINTED. DEFAULT SETTING: 1.

P42

FREQUENCY OF WINNING - FOR PRIZE #5. THIS REPRESENTS THE NUMBER OF POINTS (QUARTERS) ACCUMULATED BEFORE THE POSSIBILITY OF WINNING THE FIRST MAGIC NUMBER PRIZE (P43). REACHING THIS NUMBER DOES NOT GUARANTEE A WINNER, HOWEVER IT INCREASES THE CHANCES OF WINNING. RANGE 10-10000, SKIP COUNT 10, DEFAULT VALUE 400.

P43

SETTING OF THE FIRST MAGIC NUMBER ITSELF (RANGE 100-999, DEFAULT VALUE 777, THE FUNCTION IS OFF WHEN P43=0).

P44

COUNTER OF POINTS (QUARTERS) COLLECTED FOR THE FIRST MAGIC NUMBER PRIZE (PRIZE #5). CAN BE RESET BY PRESSING & HOLDING “START” BUTTON.

P45

COUNTER OF FIRST MAGIC NUMBER PRIZE (PRIZE #5) WINNINGS (CAN BE RESET BY PRESSING & HOLDING “START” BUTTON).

P46

FORTUNE FUN – SETTING FOR NUMBER OF CREDITS GIVEN FOR PRIZE #1 (RANGE 0-5, DEFAULT SETTING 1).

P47

FORTUNE FUN – SETTING FOR NUMBER OF CREDITS GIVEN FOR PRIZE #2 (RANGE 0-5, DEFAULT SETTING 1).

P48

FORTUNE FUN – SETTING FOR NUMBER OF CREDITS GIVEN FOR PRIZE #3 (RANGE 0-5, DEFAULT SETTING 2).

P49

NUMBER OF CREDITS INSERTED IN THE MACHINE AT ONE TIME WHICH DECREASES THE HIGHEST SCORE (IN POWER MODE). RANGE 0-50, DEFAULT VALUE: 0 (FUNCTION IS OFF).

P50

VALUE BY WHICH THE HIGHEST SCORE (IN POWER MODE) WILL BE LOWERED (SETTING WHICH WORKS WITH P49, RANGE 0-50, DEFAULT VALUE: 2).

P51

IF SET TO 1 ACTIVATES OPTION P52. DEFAULT SETTING: 0.

P52

SETTING OF THE HIGHEST SCORE IN POWER MODE (BREAK POINT) ABOVE WHICH SURPRISE BALL (CAPSULE) WILL BE DISPENSED (RANGE 100-900, DEFAULT SETTING: 500).

P53

COUNTER OF DISPENSED SURPRISE BALLS - CAPSULES (CAN BE RESET BY PRESSING & HOLDING “START” BUTTON).

P54

FREQUENCY OF WINNING - FOR PRIZE #6. THIS REPRESENTS THE NUMBER OF POINTS (QUARTERS) ACCUMULATED BEFORE THE POSSIBILITY OF WINNING THE SECOND MAGIC NUMBER PRIZE (P55). (RANGE 10-10000, SKIP COUNT 10, DEFAULT VALUE 400). REACHING THIS NUMBER DOES NOT GUARANTEE A WINNER, HOWEVER IT INCREASES THE CHANCES OF WINNING.

P55

SETTING OF THE SECOND MAGIC NUMBER ITSELF (RANGE 100-999, DEFAULT VALUE 0).

P56

COUNTER OF POINTS (QUARTERS) COLLECTED FOR THE SECOND MAGIC NUMBER PRIZE (PRIZE #6). CAN BE RESET BY PRESSING AND HOLDING “START” BUTTON FOR 10 SECONDS.

P57

COUNTER OF THE SECOND MAGIC NUMBER HITS (CAN BE RESET BY PRESSING AND HOLDING “START” BUTTON FOR 10 SECONDS).

P58

SETTING OF THE DIFFICULTY LEVEL FOR THE FORTUNE FUN.

HERE CAN BE SET PERCENTAGE OF CHANCES TO WIN (RANGE 0-9, DEFAULT VALUE 0). TO ACTIVATE THIS FEATURE **P23** MUST BE SET TO 2).

WHEN P58 IS SET ON 0 THERE IS 100 % OF WINS.

ON THE OTHER SIDE IS WHEN IT IS SET ON 9 - THERE IS A 10% CHANCE TO WIN.

TABLE OF PERCENTAGE (P58):

Setting	Percentage (of wins)
0	30
1	27
2	24
3	21
4	18
5	15
6	12
7	9
8	6
9	3

P59

UPPER SCORE LIMIT FOR PRIZE #1 (RANGE 900-999, DEFAULT SETTING: 950).

NOTE: Settings in P59 to P64 cannot overlap. For example if the lower limit for prize #1 is 900, the upper limit for prize #2 must be less than 900 and so on.

IMPORTANT: THIS GAME MODE IS ACTIVATED WITH **P23 = 3**.

P60

LOWER SCORE LIMIT FOR PRIZE #1 (RANGE 851-999, DEFAULT SETTING: 900). SEE P59.

P61

UPPER SCORE LIMIT FOR PRIZE #2 (RANGE 800-998, DEFAULT SETTING: 850). SEE P59.

P62

LOWER SCORE LIMIT FOR PRIZE #2 (RANGE 751-998, DEFAULT SETTING: 800). SEE P59.

P63

UPPER SCORE LIMIT FOR PRIZE #3 (RANGE 700-997, DEFAULT SETTING: 750). SEE P59.

P64

LOWER SCORE LIMIT FOR PRIZE #3 (RANGE 100-997, DEFAULT SETTING: 700). SEE P59.

P65

ADDITIONAL CREDIT COUNT METHOD.

IF SET TO 1 IT WILL GIVE OUT CREDIT BASED ON THE TOTAL AMOUNT OF MONEY INSERTED BEFORE PRESSING THE "START" BUTTON (IF USER INSERTS 5 SINGLES CREDITS WILL BE COUNTED SAME AS FIVE DOLLAR BILL, AN EXTRA CREDIT WILL BE GIVEN BASED ON SETTINGS IN OPTION **P05** AND **P06**).

IF SET TO 0 FOR EACH DOLLAR INSERTED USER WILL GET ONE CREDIT ONLY. BY DEFAULT THE FUNCTION IS OFF (P65=0).

P66

SETTING OF BOXER ID. THIS VALUE CAN BE CHANGED BY HOLDING THE **SW1** PRESSED AND PRESSING **SW2** FIVE TIMES. THIS WILL ALLOW CHANGING THE ID VALUE WITH BUTTONS **GAME** AND **START**. THE RANGE FOR THIS SETTING IS 0 – 65000.

P67

TIME SETTING FOR SENDING INFORMATION USING THE BOXNET FUNCTION. CURRENT STATE OF THE MACHINE WILL BE SENT IN MULTIPLE OF 10 MINUTES.

P67 = 0; FUNCTION IS OFF, NOTHING IS SENT,

P67 = 1; CYCLE BETWEEN SENDING INFO PACKETS IS
(1 x 10 = 10min),

P67 = 2; CYCLE BETWEEN SENDING INFO PACKETS IS
(2 x 10 = 20min),

P67 = 3; CYCLE BETWEEN SENDING INFO PACKETS IS
(3 x 10 = 30min).
P67 MAX VALUE = 250. DEFAULT SETTING 0.

P68

SETTING FOR FLASHING LIGHTS IN IDLE STATE:

P68 = 0; OFF,

P68 = 1 TO 60; MINUTES BEFORE LIGHTS START
FLASHING. DEFAULT SETTING: 0.

P69

SETTING FOR SOUND DELAY IN IDLE STATE:

P69 = 0; OFF,

P69 = 1 TO 60; MINUTES BEFORE SOUND STARTS
PLAYING. DEFAULT SETTING: 0.

NOTE: dip switch #3 will determine if sound will be played.

P70

AUTOPLAY –SETTING TIME AFTER WHICH MACHINE
WILL RELEASE A FREE GAME.

P70 = 0; OFF,

P70 = 1 TO 180; MINUTES BEFORE FREE GAME IS
ACTIVATED. DEFAULT SETTING: 0.

P71

PRINT PRIZE #1 (1 = **PRINT**, 0 = **DON'T PRINT**). DEFAULT
SETTING : 0.

P72

PRINT PRIZE #2 (1 = **PRINT**, 0 = **DON'T PRINT**). DEFAULT
SETTING : 0.

P73

PRINT PRIZE #3 (1 = **PRINT**, 0 = **DON'T PRINT**). DEFAULT
SETTING : 0.

P74

DEFINES HOW MANY GAMES/CREDITS CAN BE PLAYED
TILL THE MACHINE IS AUTOMATICALLY BLOCKED.

P75

COUNTER OF CREDITS LEFT BEFORE THE MACHINE WILL
BE AUTOMATICALLY BLOCKED.

P76

ACTIVATION CODE USED TO UNBLOCK THE MACHINE.

P77

ACTIVATION OF SURPRISE BALL (CAPSULE) DISPENSER WHEN PLAYER REACHES 100, 200, 300...900 POINTS OR 111, 222, 333... 999 POINTS, AS FOLLOWS:

0 - THE FUNCTION IS OFF,

1 - THE SURPRISE BALL (CAPSULE) DISPENSER IS ON FOR MULTIPLES OF 100 SUCH AS 100, 200 ...900 AND FOR TRIPLE NUMBERS SUCH AS 111, 222 ...999,

2 - THE SURPRISE BALL (CAPSULE) DISPENSER IS ON FOR MULTIPLES OF 100 ONLY,

3 - THE SURPRISE BALL (CAPSULE) DISPENSER IS ON FOR TRIPLE NUMBERS ONLY.

DEFAULT SETTING IS 0 (OFF).

P78

ACTIVATION OF SURPRISE BALL (CAPSULE) DISPENSER WHEN PLAYER BREAKS THE RECORD (HIGH SCORES IN POWER MODE). WHEN SET TO 1 THE FUNCTION IS ON, WHEN SET TO 0 - IT IS OFF. DEFAULT SETTING: 0.

P79

DEFINES HOW MANY FREE CREDITS WILL BE GIVEN WHEN PLAYER REACHES MULTIPLE OF 100 SCORE (RANGE 0-10, DEFAULT SETTING: 0).

P80

DEFINES HOW MANY FREE CREDITS WILL BE GIVEN WHEN PLAYER REACHES TRIPLE NUMBER SCORE (RANGE 0-10, DEFAULT SETTING: 0).

P81

RELAX – TIME FOR WHICH HALOGEN LAMP WILL BE ON (0-50). DEFINED: 1 IS AN EQUIVALENT OF 0,1 SECONDS. DEFAULT SETTING IS 0 – RELAX FUNCTION IS OFF.

- Example: when P81=5 it means the halogen lamp will be ON for 0,5 seconds.

- Example: when P81=0 it means that the halogen lamp is not working in Relax Mode.

IMPORTANT:

IF HALOGEN LAMP NEEDS TO BE ON ALL THE TIME IN RELAX MODE THE VALUE OF P81 ALWAYS NEEDS TO BE HIGHER THAN P82 (COMPARING THIS IN SECONDS, EXAMPLE: P81=11 AND P82=1).

IN OTHER WORDS THE BEST WAY TO ACHIVE THIS IS TO SET P81 TO HIGHER NUMBER THAN 0 ($P81 > 0$) AND SET P82 TO 0 ($P82 = 0$).

P82

RELAX – DEFINES FREQUENCY OF HOW OFTEN HALOGEN LAMP WILL NOT SHINE (GIVEN IN SECONDS). RANGE 0-60, DEFAULT SETTING IS $P82 = 0$.

- Example: when P82 is set to 10, every 10 seconds halogen will not shine (pause).

SUMMARY:

WHEN WE WANT THE HALOGEN TO LIGHT FOR 0,5 SECONDS WITH 2 SECONDS PAUSE P81 NEEDS TO BE SET TO 5 AND P82 - TO 2. IF HALOGEN HAS TO BE OFF IN RELAX MODE, P81 NEEDS TO BE SET TO 0 AND P82 – TO ANY OTHER DIGIT.

WHEN WE WANT TO HAVE HALOGEN LIGHT TO BE ON ALL THE TIME (CONSTANTLY) IN RELAX MODE P81 NEEDS TO BE SET TO ANY DIGIT HIGHER THAN 0 AND P82 – TO 0 ($P81 = \text{ANY DIGIT} > 0$, $P82 = 0$) OR SET P81 HIGHER THAN P82 ($P81 > P82$) IN THAT WAY, THAT CALCULATED TIME IN SECONDS IN P81 IS HIGHER THAN IN P82.

P83

MULTI TOURNAMENT - WHEN SET TO 1 THE FUNCTION IS ON, WHEN SET TO 0 - IT IS OFF.

THIS MODE DISABLES REFLEX AND SPEED GAMES. ONLY POWER AND TOURNAMENT GAMES ARE ACTIVATED. BY DEFAULT THIS FUNCTION IS OFF ($P83 = 0$).

IMPORTANT:

TO ACTIVATE MULTI TOURNAMENT: P83 NEEDS TO BE SET TO 1. TO ACHIEVE THE EFFECT THE MACHINE NEEDS TO BE SWITCHED OFF AND BACK ON.

P84

DEFINES HOW MANY CREDITS NEED TO BE RECEIVED BY THE MACHINE IN ORDER TO ACTIVATE ASSISTING FUNCTION SET IN P85 (RANGE 0-999, DEFAULT VALUE 0). WHEN SET TO 0 THE FUNCTION IS OFF.

P85

ACTIVATION OF THE FUNCTION ASSISTING IN WINNING THE SURPRISE BALL (CAPSULE) SET IN **P77**. THE SETTING DEFINES THE RANGE OF POINTS, 0 TO 10, WHICH ARE

BEING USED TO ACHIEVE THE WINNING NUMBER. WHEN SET TO 0 THE FUNCTION IS OFF. DEFAULT VALUE: 0 – NO HELP SCORING PRIZES.

P86

DEFINES FREQUENCY OF RESETTING HIGH SCORES - TIME IN HOURS. AVAILABLE RANGE IS 0 TO 240. IF SET TO 0 THEN THE FUNCTION IS OFF. DEFAULT VALUE: 0.

NOTE:

THIS TIME IS CALCULATED FROM THE LAST RESETTING EITHER AUTOMATIC OR MANUAL (USING THE DIP SWITCH #4). WORKS WITH P87.

P87

DEFINES FOR HOW LONG (TIME IN MINUTES) MACHINE NEEDS TO BE IN THE IDLE STATE (NOT OPERATED BUT TURN ON) FOR THE SCORES TO BE RESET. THE LIMIT OF HOURS IN P86 MUST BE FIRST MET. AVAILABLE RANGE IS 0 TO 240. IF SET TO 0 THEN THE FUNCTION IS OFF. DEFAULT VALUE: 1. SET IT ALONG WITH P86.

P88

PARAMETER USED BY FACTORY.

P89

SURPRISE BALL (CAPSULE) DISPENSE SETUP FOR WINNING THE PRIZE FROM WHEEL OF FUN/ FORTUNE FUN (WHEN **P11 = 2** AND **P23 = 1** OR **P23 = 2**). RANGE 0-7, DEFAULT SETTING IS 0.

P89 value	Prize #1	Prize #2	Prize #3
0	OFF	OFF	OFF
1	ON	OFF	OFF
2	OFF	ON	OFF
3	ON	ON	OFF
4	OFF	OFF	ON
5	ON	OFF	ON
6	OFF	ON	ON
7	ON	ON	ON

- Example: when P89 is set to 5 then the ball will be dispensed only if the player wins prize #3 or prize #1. Winning prize #2 will not trigger the ball dispenser.

SETTINGS FOR THE DUNK TANK OPTION.

P21

DUNK TANK 1 – “ON”, 0 – “OFF”

P22

ACTIVATION OF THE DUNK TANK, WHEN THE NEW POWER RECORD IS ESTABLISHED, 1 – “ON”, 0 – “OFF”

P23

ACTIVATION OF THE DUNK TANK, WHEN THE TRIPLE NUMBER IS REACHED (444,555, ETC.), 1 – “ON”, 0 – “OFF”

P24

ACTIVATION OF THE DUNK TANK, WHEN THE CERTAIN NUMBER IS REACHED (EQUALL OR LARGER, THE NUMBER IS SET IN P25), 1 – “ON”, 0 – “OFF”

P25

SETTING OF THE NUMBER AT WHICH THE DUNK TUNK WILL BE ACTIVATED. BY PRESSING THE “START” BUTTON – NUMBERS GOING UP, “SELECT GAME” BUTTON – NUMBER GOING DOWN. BY PRESSING AND HOLDING THE BUTTONS, NUMBERS WILL CHANGE BY LARGER INCREMENTS.

Switch #2

WHEN "ON" MACHINE IS SET FOR FREE PUNCH.

Switch #3

IF ON "DEMO" WILL PLAY EVERY 2 MINUTES, WHEN THE MACHINE IS NOT USED. IF "OFF" THE SOUND IS TURNED OFF.

Switch #4

WHEN "ON" THE HIGHEST SCORE FOR EACH GAME WILL BE RESETTED AFTER YOU PUSH THE "START BUTTON". WHEN "OFF" THE TOP SCORES WILL STAY DISPLAYED.

Switch #5

WHEN "ON" YOU WILL ACTIVATE UNATTAINABLE RECORD (HIGHEST SCORE) WHICH YOU MUST SET BEFORE IN P08 (SERVICE KEY).

REMEMBER: TO ACTIVATE THIS RECORD YOU MUST TURN OFF AND TURN ON THE MACHINE.

Switch #6

IF "ON" TOURNAMENT GAME FOR UP TO 6 PLAYERS, IF "OFF" TOURNAMENT GAME FOR 3 PLAYERS.

REMEMBER: TO ACTIVATE THIS SETTING YOU MUST TURN OFF AND TURN ON THE MACHINE.

Switch #7,8

NOT USED

Sensitivity switch (S2).

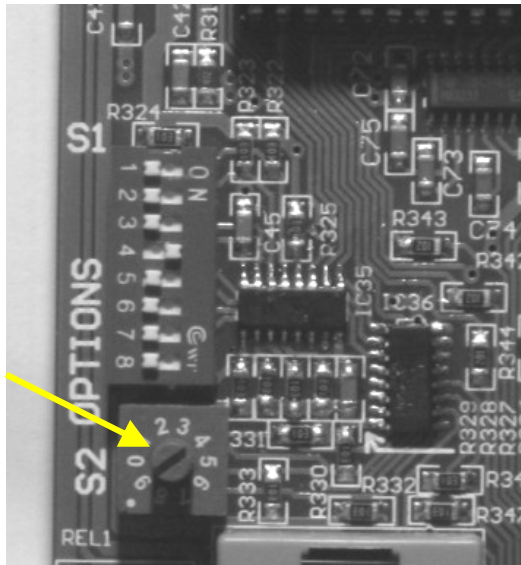

THE SENSITIVITY CAN BE CHANGED BY ROTATING SWITCH S2. AFTER THE SWITCH IS ROTATED THE SENSITIVITY LEVEL WILL BE SHOWN ON THE CREDIT DISPLAY. LOWER LEVEL NUMBERS CORRESPOND TO GREATER DIFFICULTY.

Main Board Layout (Front)

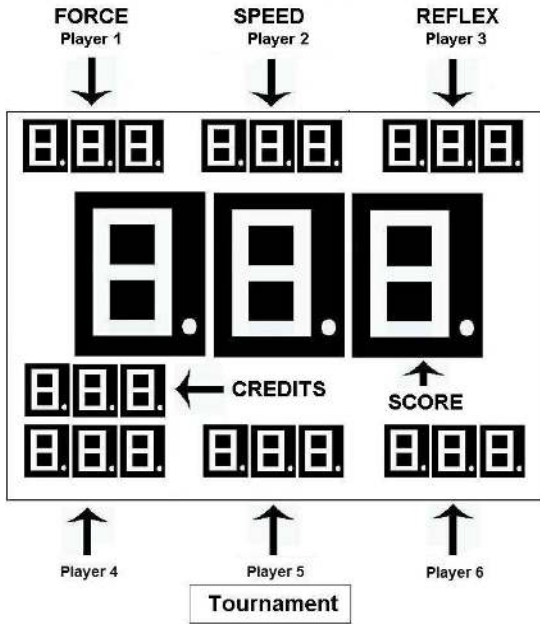

Drawing #2

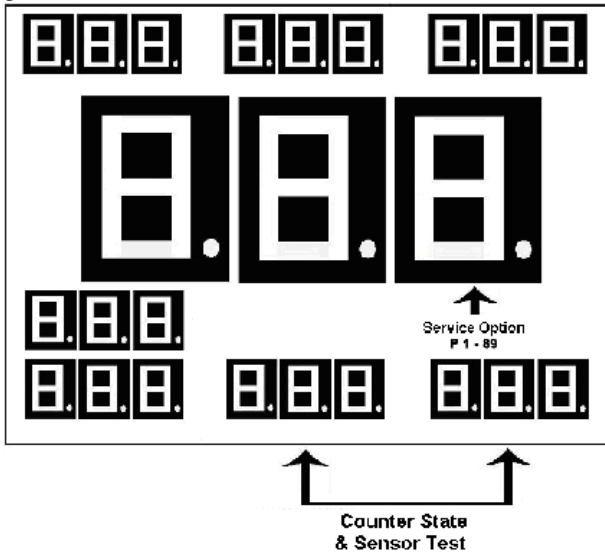

Drawing #3

Power Supply Layout:

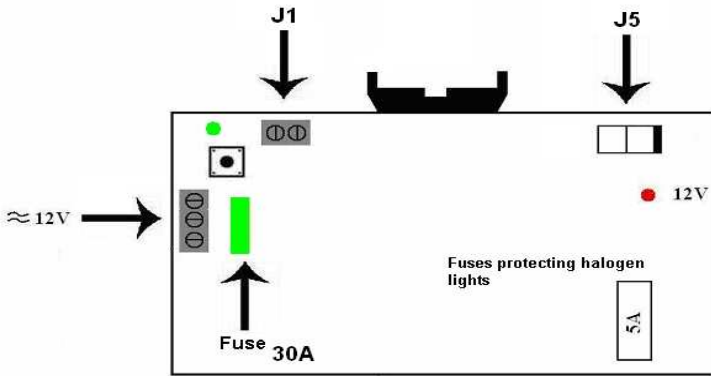

Drawing #4

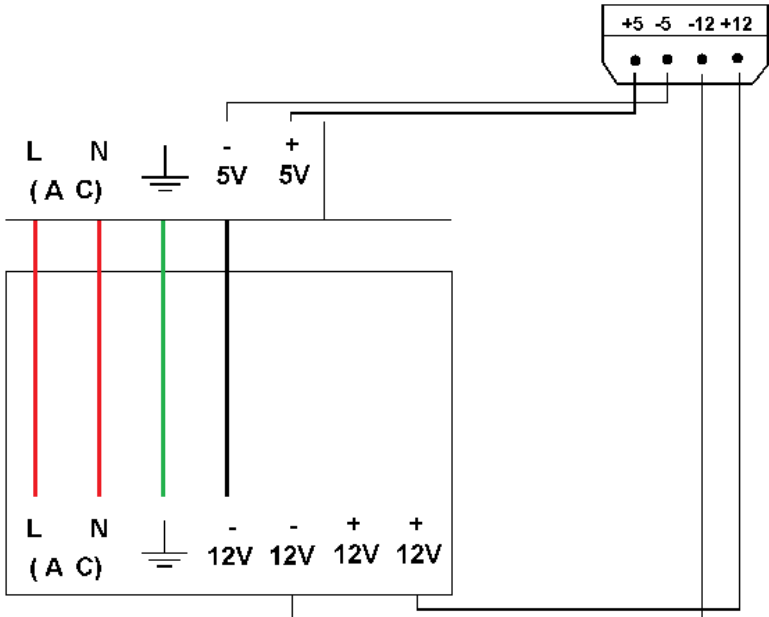

Drawing #5

Mechanical counter

- 2 – wire from mechanical counter
- 1 – wire from mechanical counter

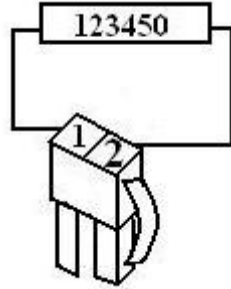

Sensor

- 1- Emitter
- 2- Cathode
- 3- Anode
- 4- Collector

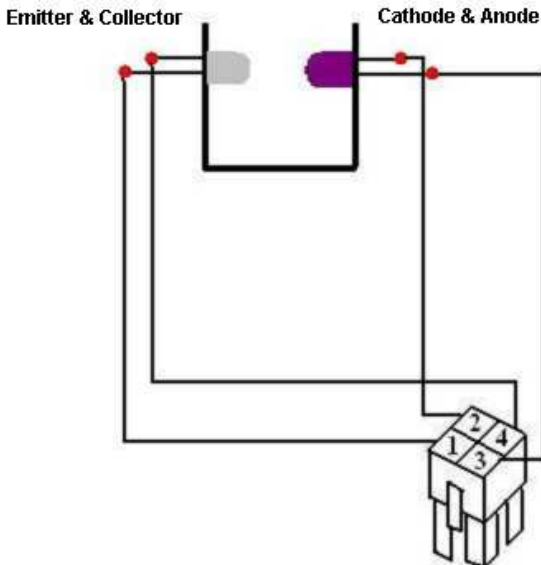
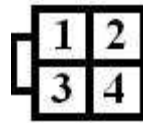

Buttons Start & Game

- 1 & 2 – START game

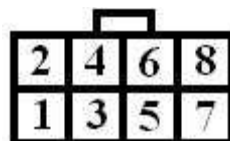

- 3 & 4 – GAME selection
- 5 & 6 – bulbs lighting button Start
- 7 & 8 – bulbs lighting button Game

Speaker

- 1 - speaker
- 2 - speaker
- 3 - unused
- 4 - unused

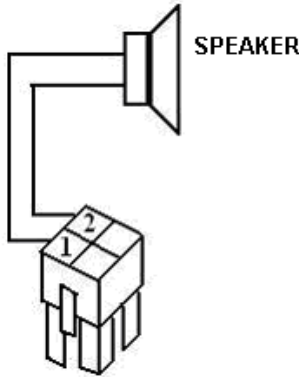

J4

Ticket dispenser

- 1 - red (+12V)
- 2 - green (signal)
- 3 - black (-12V)

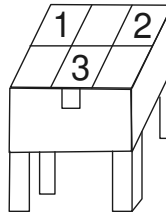

Hopper

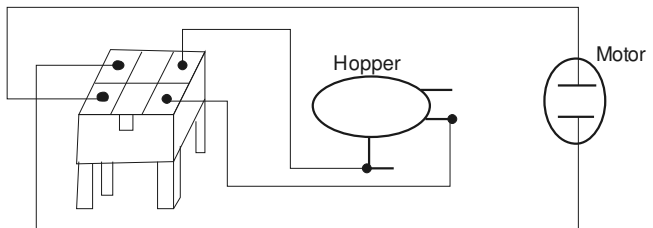

Thermal printer

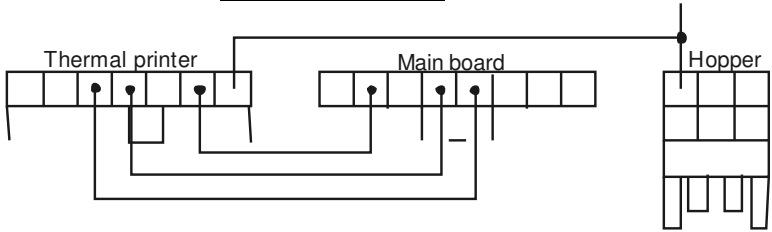

J5

- 1 – tournament (-)
- 2 – tournament (+)
- 3 – 100 (-)
- 4 – 100 (+)
- 5 – 300 (-)
- 6 – 300 (+)
- 7 – 500 (-)
- 8 – 500 (+)
- 9 – 700 (-)
- 10 – 700 (+)
- 11 – 900 (-)
- 12 – 900 (+)
- 13 – Select Game (-)
- 14 – Select Game (+)
- 15 – Force (-)
- 16 – Force (+)

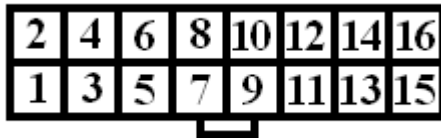

J7

- 1 – 100 (-)
- 2 – 100 (+)
- 3 – 300 (-)
- 4 – 300 (+)
- 5 – 500 (-)
- 6 – 500 (+)
- 7 – 700 (-)
- 8 – 700 (+)

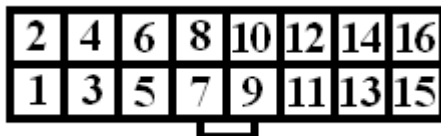

- 9 – 900 (-)
- 10 – 900 (+)
- 11 – Select Game (-)
- 12 – Select Game (+)
- 13 – speed (-)
- 14 – speed (+)
- 15 – Reflex (-)
- 16 – Reflex (+)

Paper Money Depositor

- 1 – Credit relay (Common) normally purple. Pin#8 at the ICT connector
- 2 – +12V (Power) normally red. Pin#5 at the ICT connector
- 3 – GND (Power) normally orange. Pin# 9 at the ICT connector
- 4 – Credit relay (N.O) normally blue. Pin# 7 at the ICT connector

11. Spare parts and equipment

- leveling legs 4 pieces
- punching bag pump 1 piece
- bladder 1 piece

12. Standard replacement parts

- Front panel bulbs (#73 bulb)
- SELECT GAME button bulb (#161)
- Main power supply (Switching power supply – 12V, 12A - 5V, 5A)
- Halogen bulb (12v 20W, MR11/C (GU4) – 35mm DIA.)

13. Required tools and equipment for servicing the boxing game

- Metric wrench set from 8mm to 19mm (preferably with ratchet)
- Long Allen wrench from 8mm to 19mm
- Snap ring pliers for inside diameters

- Phillips and flat screwdrivers
- Glue gun
- Volt meter
- Bag inflator (supplied with the machine)
- Pliers
- Wire stripper
- Hook and loop (Velcro) stripes
- Plastic wire ties

14. Step by step setup and maintenance instructions

HOW TO ACCESS QUICKLY RESETABLE (P01) AND NOT RESETABLE (P02) MONEY COUNTERS

P01 and P02 counters can be checked (at the same time) without going into service program, by pressing switch SW1 ↑. The SW1 switch is located in the lower left part of the main board, right above ribbon cable connecting main board with side power supply (small board). The displayed numbers will appear for 30 seconds. During that time counter P01 can be reset by pressing and holding switch SW1 for 3 seconds (after resetting machine will switch to regular work mode).

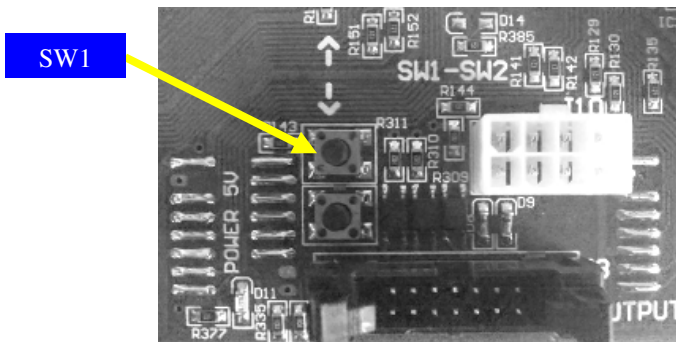

HOW TO ACCESS QUICKLY RESETABLE (P01) MONEY COUNTER (without opening the machine):

P01 counter can be displayed without using service functions or opening the back doors by pressing and holding START and GAME (SELECT) buttons in the same time for 5 seconds. The P01 counter will be appear for 15 seconds.

HOW TO TEST COIN OR BILL ACCEPTOR

The test of bill and coin acceptor can be done without changing the meter reading by pressing and holding START and GAME (SELECT) buttons in the same time for 5 seconds. On the main

display P01 will appear. At that time bills and coins can be inserted for a test. After inserting every single coin (bill) testing time will be extend for another 15 seconds. If the testing mode is not used for 15 seconds, machine will switch to regular working mode.

HOW TO SET-UP PRICE OF THE GAME PLAY.

Enter the settings mode by powering up the machine and switching DIP switch #1 to ON position.

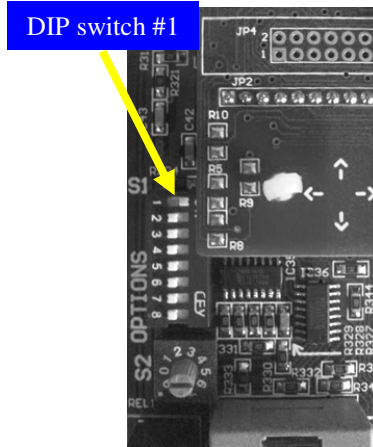

The main display should now indicate the settings mode with 'P 1' as shown.



Press the **SW1** button repeatedly on the main board until the main display reads 'P 4'. If you get too far on this menu you can always get back with the **SW2** button.

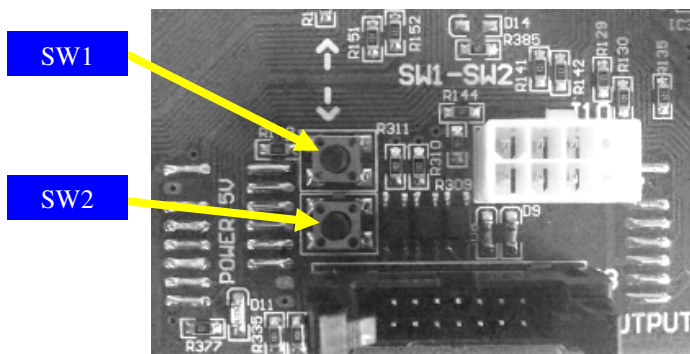

Now you can modify the setting to set-up the price of the game play (If one game credit is to cost \$1 the setting would then be 4 -1, meaning that 4 quarters equals one punch). There is one number you must set here and this is done by the machine's **START** button in the front. After you are done the display should look like the following picture if you chose these settings.



To leave the settings mode simply turn the DIP switch #1 to off (left) position.

The machine should reset and be ready to go.

HOW TO SET UP BONUS POINTS

Enter the settings mode by powering up the machine and switching DIP switch #1 to ON position.

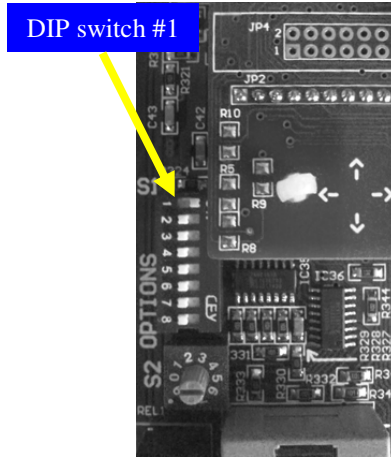

The main display should now indicate the settings mode with '**P 1**' as shown.



Press the **SW1** button repeatedly on the main board until the main display reads '**P 5**'. If you get too far on this menu you can always get back with the **SW2** button.

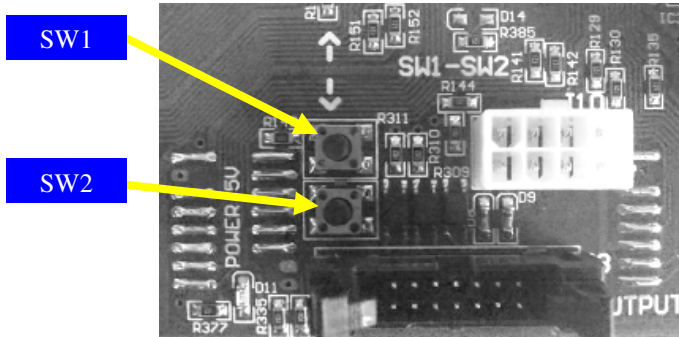

This setting corresponds to the number of credits given when a set dollar amount is put in the machine. For example: you want to set 8 credits (punches) for \$5 ($5 \times 4 = 20$ quarters), you should adjust this setting to indicate 20-8 as shown.



The values can be set using **START** and **GAME** buttons. As shown, **START** sets the left value and **GAME** sets the right value. Repeat the procedure for 'P 6' but remember to set the bonus for a larger amount of money than in 'P 5'. Example could be for \$10, 20 credits ($10 \times 4 = 40$, so the setting is 40-20). If you get too far while increasing these values you must continue going up to 100 before you again end up at single 0.

To leave the settings mode simply turn the DIP switch #1 to off (left) position. The machine should reset and be ready to go.

HOW TO SET UP 'WHEEL OF FUN' FUNCTION

Enter the settings mode by powering up the machine and switching DIP switch #1 to ON position.

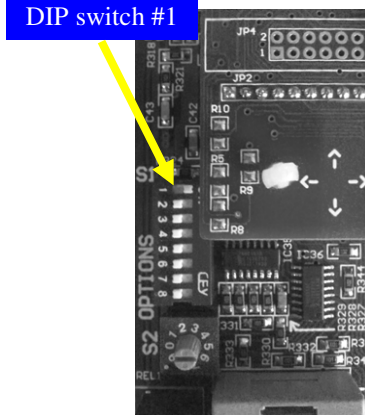

The main display should now indicate the settings mode with '**P 1**' as shown.



Press the **SW1** button repeatedly on the main board until the main display reads '**P 23**'. If you get too far on this menu you can always get back with the **SW2** button.

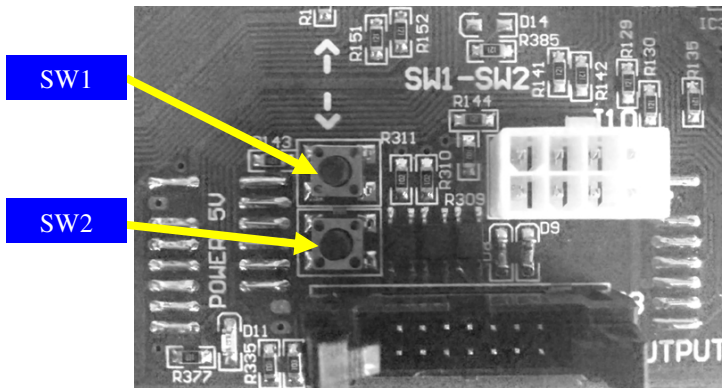

The single digit number on the lower right display is the ‘Wheel of Fun’ mode. To enable this function set this number to ‘1’ by pressing the START button. If the machine is not equipped with this wheel then this setting should remain ‘0’. The picture below illustrates the enabled mode for the wheel of fun.



Another important setting for the wheel of fun is the frequency of winning prizes. There are three levels of prizes the player can win with this wheel. They correspond to number 1, 2, and 3 on the wheel as pictured below. The frequency of stopping on one of these places can be adjusted with the following procedure.

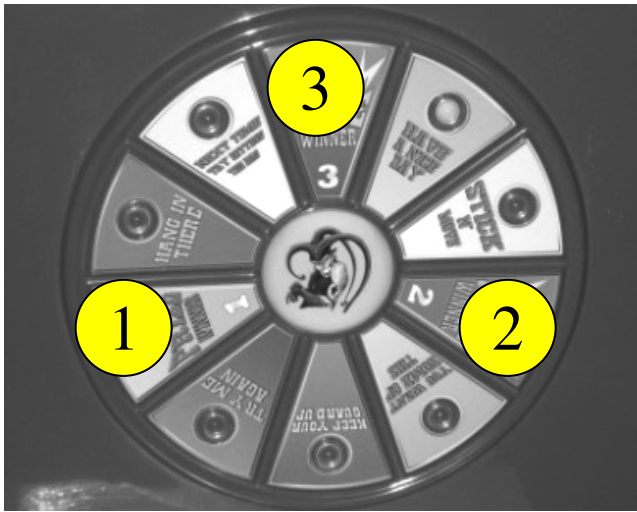

After you set menu item ‘P23’ as described above go up to ‘P24’. This is for setting the frequency of winning prize #1. Here you must set the value (number of quarters) that the machine must collect before unlocking the first prize. This value is set using the **START** and **GAME** buttons. For example let’s adjust this setting for \$100 or 400 quarters. The display should look like the following picture.



Similarly, you must set the frequency of winning for prizes

2 and 3. These are menu items 'P25' and 'P26'. If we set these for \$50 and \$25 the display should show the following. Always remember that the values in these settings are in quarters.



To leave the settings mode simply turn the DIP switch #1 to off (left) position. The machine should reset and be ready to go.

HOW TO SET UP MAGIC NUMBER

The magic number can be any 3 digit combination. The magic number as well as the frequency of hitting that number must be set. Enter the settings mode by powering up the machine and switching DIP switch #1 to ON position.

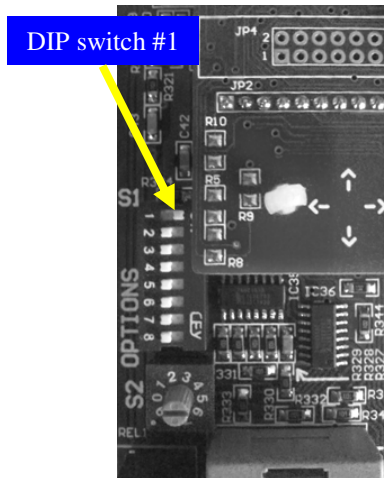

The main display should now indicate the settings mode with 'P 1' as shown.



Press the **SW1** button repeatedly on the main board until the main display reads '**P43**'. If you get too far on this menu you can always get back with the **SW2** button.

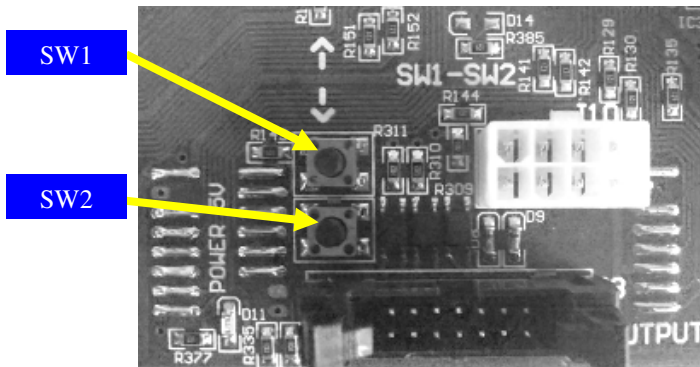

Use the **START** and **GAME** buttons to adjust the value of the magic number as desired. Press the **SW2** button to get to setting '**P42**', which is the minimum amount of credits collected by the machine to unlock the possibility of hitting that number. Here again use the same buttons to adjust the value. Remember that this value is counted in quarters. In this example the machine collects \$100 before unlocking the magic number (400 quarters = \$100). It becomes possible then for the player to hit the bag and get a score of '**777**'. The two pictures illustrate the magic number setting for this case.



To leave the settings mode simply turn the DIP switch #1 to off (left) position. The machine should reset and be ready to go.

HOW TO RESET HIGH SCORES MANUALLY

If you feel the score on the game reached an unbeatable number you can reset this score to the default value (see setting P30). Enter the reset mode by powering up the machine and switching DIP switch #4 to **ON** position.

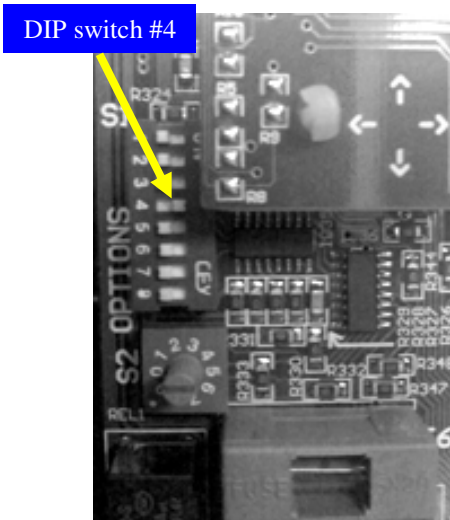

You will not see any changes on the display and the game will remain in playable mode. This is why it is important to remember to switch the machine back from this mode when done resetting. Next, press and hold the **START** button on the machine for about 10 seconds. When the score resets on the main display then release the **START** button and put DIP switch #4 back to **OFF** position.

HOW TO RESET HIGH SCORES AUTOMATICALLY

If you want the machine to automatically reset the highest score (of Power Mode) so that it does not get too high, follow the instructions below. The highest score will be reset to the value programmed in setting P30 (see setting P30).

Enter the settings mode by powering up the machine and switching DIP switch #1 (on the main board) to ON position.

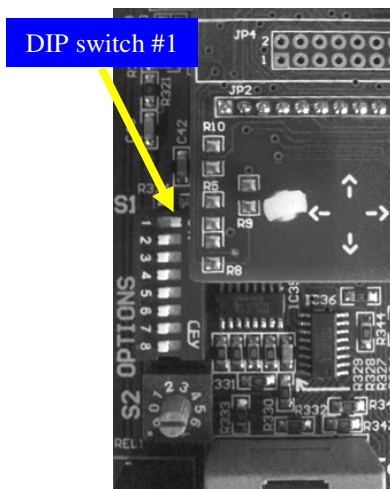

The main display should now indicate the settings mode with '**P 1**' as shown.



Press the **SW1** button repeatedly on the main board until the main display reads '**P88**'. If you get too far on this menu you can always get back with the **SW2** button.

Using **START** button on the front of the machine set number of hours (counted from the last resetting) after which the highest score should be reset automatically, eg. set 120.



Then press the **SW1** button once - the main display should read '**P87**'. Using **START** button on the front of the machine set number of minutes (counted when machine is in idle state after the time set in P86 above has already passed) after which the highest score will be reset, eg. 15.



SUMMARY: With above settings the machine will count 120 hours from the last resetting (either manual or automatic), and then, if machine is in idle state for more than 15 minutes the highest score will be reset.

HOW TO ERASE CREDITS

Erasing the game's credits can be done with the following procedure. Enter the settings mode by powering up the machine and switching DIP switch #1 to ON position.

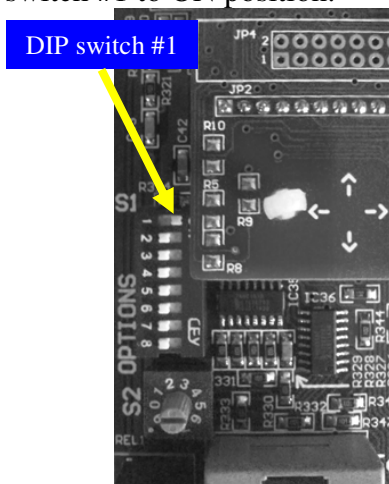

The main display should now indicate the settings mode with 'P 1' as shown.



Press the **SW1** button repeatedly on the main board until the main display reads '**P20**'. If you get too far on this menu you can always get back with the **SW2** button.

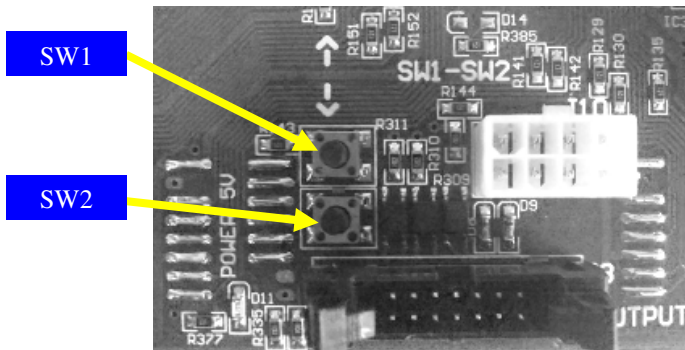

Press the **START** button located in the front of the game. When finished don't forget to set DIP switch #1 back to OFF position.

HOW TO CHANGE THE PUNCHING BAG

Changing the punching bag is required in some cases. Lower the bag arm as in the play mode and ready to punch. Take off the front guard and unscrew the top nut using 19 mm wrench (use wrench with a ratchet). This will release the bag assembly.

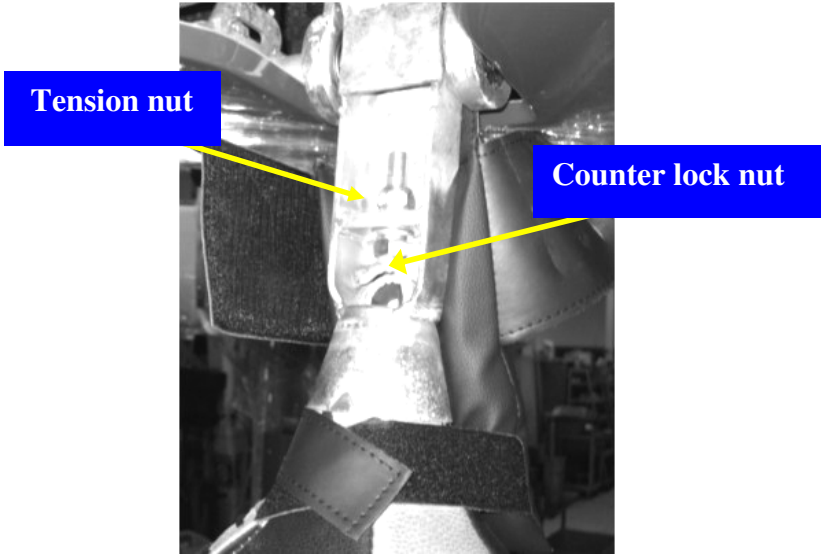

To install a new bag first make sure that the tension nut is taken off and the second nut is screwed all the way on the bolt. Otherwise the second bolt will prevent the bag from properly tightening of the assembly. Insert the bag in its place, replace the tension nut and tighten it until the bag cannot be twisted by manual tests. To test this grab the bag in your arm and simply use your body's weight to try to twist the bag on the bolt's axis.



If it is secured tight enough, then finish by unscrewing the second nut until it tightens on the metal arm.

HOW TO RELEASE THE PUNCHING BAG MANUALLY

Sometimes it is necessary to release the punching bag when the machine has no power. This can still be done manually. You must reach over the bag and find the mechanical hammer holding the entire arm in position. Then using your thumb press the hammer which is under compression by a spring behind it and the bag should be free to come down.



HOW TO CHANGE THE FUSE IN THE MAIN SWITCH

Locate the power cord connection on the back of the machine. The fuse can be found hidden between the power cord socket and the main ON/OFF switch. In order to replace it use a flat screwdriver to pry open the fuse holder and pull it out.



HOW TO CHECK THE SOLENOID

Proper operation of the solenoid can be verified by releasing the punching bag electronically. This can be done by pushing a release button located on the side power supply (not the main board). Power up the machine and press this button. If the bag is released the solenoid is working.



If the bag does not come down there may be a problem with the solenoid. Remove the two solenoid wires connected to the power supply circuit board. Unscrew the two terminals and pull these wires out.

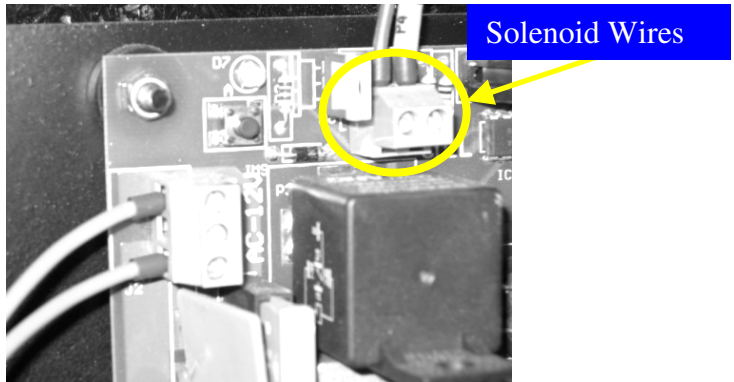

Check resistance on these two terminals with a multi-meter. The resistance should be very low around 0.5Ω . If your meter shows overload or infinite resistance the solenoid coil may be damaged. In that case replacing the solenoid is necessary.

The solenoid can be evaluated in another way if for example you do not have a multi-meter handy. This also involves unscrewing the two terminals and pulling out the two wires. Instead of measuring the resistance as described above make a temporary connection with direct 12 V supply by touching the two wires onto the input voltage terminal as shown in the picture below.

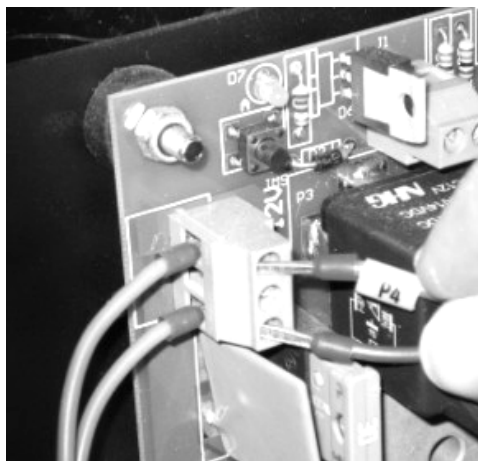

MAIN BOARD SETTINGS

P1		P31		P61	
P2		P32		P62	
P3		P33		P63	
P4		P34		P64	
P5		P35		P65	
P6		P36		P66	
P7		P37		P67	
P8		P38		P68	
P9		P39		P69	
P10		P40		P70	
P11		P41		P71	
P12		P42		P72	
P13		P43		P73	
P14		P44		P74	
P15		P45		P75	
P16		P46		P76	
P17		P47		P77	
P18		P48		P78	
P19		P49		P79	
P20		P50		P80	
P21		P51		P81	
P22		P52		P82	
P23		P53		P83	
P24		P54		P84	
P25		P55		P85	
P26		P56		P86	
P27		P57		P87	
P28		P58		P88	
P29		P59		P89	
P30		P60		P90	

MAINTENANCE LOG	Date of Service					
	Punching bag condition					
	Punching bag pressure					
	Arm protector condition					
	Arm protector position					
	Legibility of disclaimer					
	Legibility of instruction					
	Level of machine					
	Grease on mechanism					
	Bulbs					
	Buttons					
	Bill and coin validators					
	Safe condition (Yes/No)					
	SERIAL NO	If not working or condition not safe for use what was replaced				
Comments						
Signature						