



MUSTANG

PRO



Ford Oval and nameplates are registered trademarks owned and licensed by Ford Motor Company.

WARNING

Important Health Warning: PHOTSENSITIVE SEIZURES

A very small percentage of people may experience a seizure when exposed to certain visual images, including flashing lights or patterns. Even people with no history of seizures of epilepsy may have an undiagnosed condition that can cause "photosensitive epileptic seizures" due to certain visual images, flashing lights or patterns. Symptoms can include light-headedness, altered vision, eye or face twitching, jerking or shaking of arms or legs, disorientation, confusion, momentary loss of awareness, and loss of consciousness or convulsions that can lead to injury from falling down or striking nearby objects.

IMMEDIATELY STOP PLAYING AND CONSULT A DOCTOR IF YOU EXPERIENCE ANY OF THESE SYMPTOMS.

Please visit www.sternpinball.com

For part numbers and mechanical drawings.

Stern Pinball machines are assembled in Melrose Park, Illinois, USA; each pinball machine has unique characteristics that make it a one of a kind American made product. Each machine will have variations in appearance resulting from differences in the machine's particular wood parts, individual silk screened art and mechanical assemblies. Stern Pinball has inspected each game element to insure it meets our quality standards.

Pinball Service Game Manual

Please call, email, or visit us online for technical support, questions or comments regarding this pinball game.

Go to www.sternpinball.com and click **SERVICE & SUPPORT**.

Find **Service Game Manual** (with updates), **Coin Cards**, **Game Code Library**, **Appendixes**, **Care & Maintenance**, **Service Bulletins** and much more!

Toll-Free: 1-800-KICKERS (542-5377) or 1-708-345-7700 • Email: parts.service@sternpinball.com

Stern® Pinball, Inc.
All Rights Reserved.
Printed in the U.S.A.
JANUARY 2014

SPI Part Number
780-50F1-00

HOW TO UPDATE YOUR GAME CODE FOR S.A.M. SYSTEM MACHINES

USB Compatible Data Storage Device (Thumb, Flash or Jump Drives) required to copy game code into system.
S.A.M. System compatible, tested & SPI approved USB Data Storage Devices 128MB+ available through your local distributor. Ask for **SPI Part Number 970-0128-00**

* to get the Data Storage Device with the latest Game Code copied to it, add 'game title' to above part number.

STYLE, COLOR, SIZE AND MANUFACTURER SUBJECT TO CHANGE.

Game Code is subject to change. Update this game with the latest code downloaded from our website, from another game or order through your local distributor (use SPI PN + name above).

Upon power-up the display will describe the version of code installed in your game. When directed to do so (via Service Bulletin or website announcement) you will need to update your code ... with the **BOOT FLASH EPROM*** installed, here's how:

- STEP 1** Open the Back Box and locate the **8-Position Dip Switch (SW1 on the CPU/Sound Board)**.
- STEP 2** Switch Dip Switch #8 to 'ON'.
(***BOOT FLASH EPROM** must be installed.)
- STEP 3** Press the **White Reset Button (S1 RESET on the CPU/Sound Board)** or Power Cycle the game **OFF/ON** (ON/OFF Switch is located on the outside of the cabinet bottom, front right).
- STEP 4** Using the **4-Button Service Switch Set** (inside the Coin Door):
- 4A) Press [SELECT] to begin.
- 4B) With the "UPDT" icon highlighted, press [SELECT].
- 4C) Insert the Data Storage Device [w/latest file(s)] into the USB Port.
- 4D) If more than one file is present on the Data Storage Device, press [<] or [>] to locate your file. Press [SELECT] to update.
- 4E) Follow on-screen prompts.



• **Green Button**
Press to
Escape
Back
(or Exit).

•• **Red Buttons**
Press to move
< Left, Right >.
Press to - Decrease
or + Increase values
or to change settings.

• **Black Button**
Press to
Enter
Select
(or 'OK').

CPU/Sound Board (S.A.M. System)

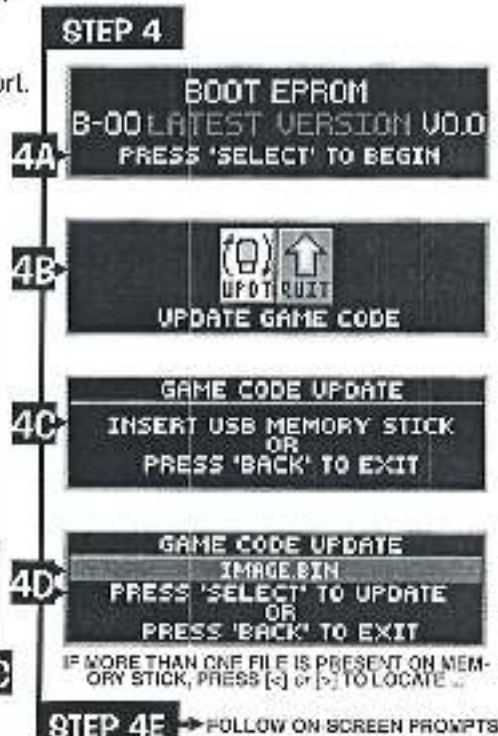
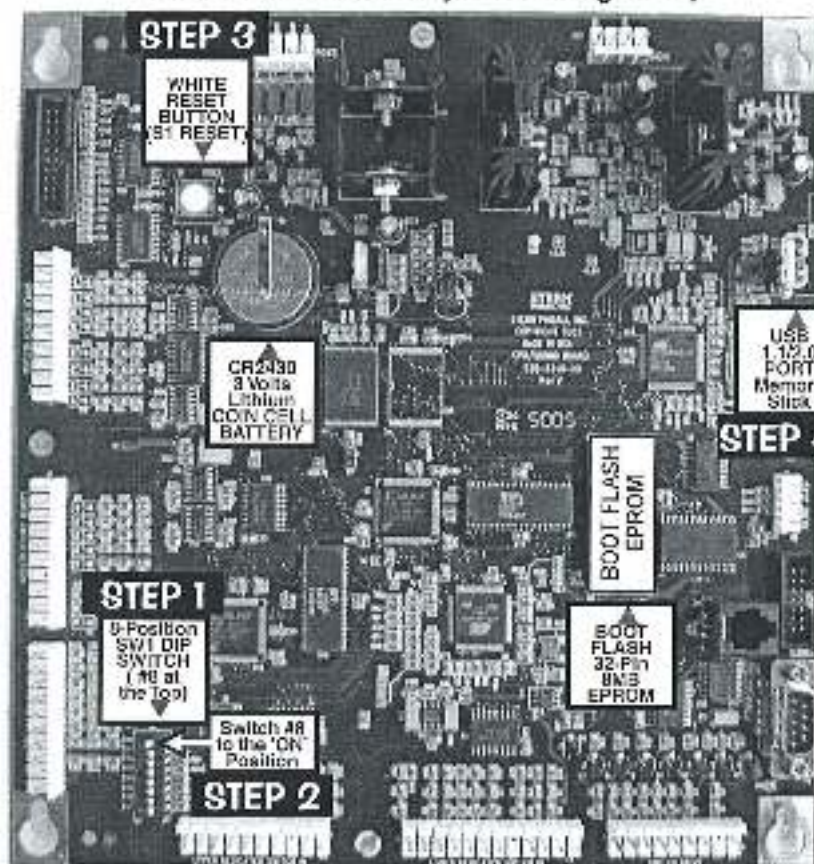

You can also retrieve your latest code from another game! From the **USB MENU** via the **UTILITIES MENU**, select the "BKUP" icon instead and download to your Data Storage Device.



! Quick Tip - Try backing up your current code prior to installing your new code, just in case your Data Storage Device file was corrupted by a computer glitch while you were copying /

Get confused? Comments? Questions? Call Technical Support at 800-542-5377 or 708-345-7760 (Option 1).

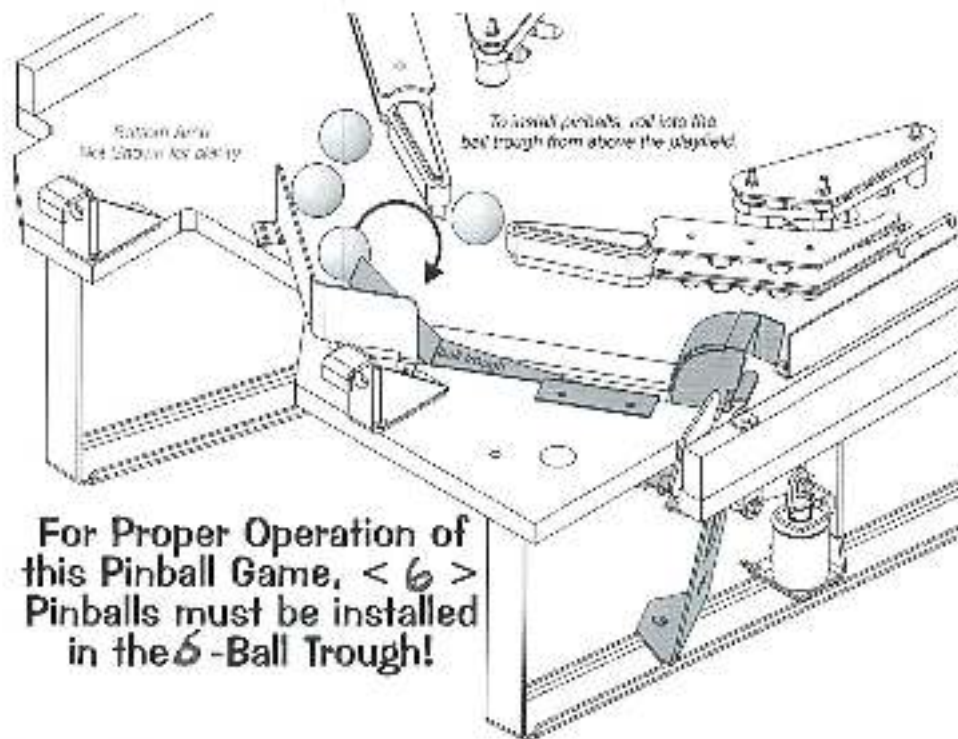

For Proper Operation of this Pinball Game, <6> Pinballs must be installed in the 6-Ball Trough!

Backbox Fuses*, Cabinet Fuses, Playfield Fuses and Cabinet Switches

*Note: The CPU/Sound PCB does not have fuses.

QUICK REFERENCE FUSE CHART	
3WA S.D. 203-5000-17 3A S.B. 203-5000-09 4A S.D. 203-5001-05 5A S.B. 200-5000-01 7A S.D. 203-5000-03 8A S.B. 203-5000-06	
BACKBOX FUSES	
I/O POWER DRIVER BOARD	
with RED LED STATUS INDICATORS (If any RED LED is OFF, check the fuse)	
F1	5A S.B. 5.7vac-G. Lamps (BLACK/WHITE-WHITE/BRN)
F2	5A S.B. 5.7vac-G. Lamps (YELLOW/WHITE-YEL. Green)
F3	5A S.B. 5.7vac-G. Lamps (GREEN/WHITE-GRN/GOLD)
F4	5A S.B. 5.7vac-G. Lamps (RED/WHITE-RED/GOLD)
F5	7A S.B. 50VDC Coils / Flipper (14VAC lead to BRDG 1)
F6	3A S.B. 24vac- Motor or Special Application
F7	4A S.B. 50VDC Magnet(s) or Special Application
F8	3A S.B. 50VDC Coils
F9	8A S.B. 18VDC Control Lamps (10VAC lead to BRDG 4)
F10	5A S.B. 20VDC Coils / Flashers (16VAC lead to BRDG 3)
F11	4A S.B. 5VDC Logic Power (8VAC lead to BRDG 3)
F12	5A S.B. 12VDC Audio (19VAC lead to BRDG 3)
F13	5A S.B. 12VDC Audio (19VAC lead to BRDG 3)
DISPLAY POWER SUPPLY BOARD	
F1	9A S.B. 95VDC High Voltage Coil Display Board
CABINET FUSES	
POWER (SERVICE OUTLET) BOX	
(Access through Coin Door inside cabinet, from bottom)	
8A S.B.	110-120V Main Line (US / Canada / Japan)
5A S.B.	220-240V Main Line (International)
PLAYFIELD FUSES	
FLIPPER OR SPECIAL APPLICATION	
(Coil Fuses are located under the playfield near assembly)	
3A S.D.	50VDC R. Flipper (BLU/YEL-RED/YEL)
3A S.B.	50VDC L. Flipper (GRY/YEL-RED/YEL)
3A S.B.	50VDC Additional Flipper Coil, if used
3A S.B.	50VDC Special Application Coil, if used
For location & more details on fuses, see Sect. 3, Chpt. 2	
ALL FUSES ARE 250V S.D. (SLO-BLO) SEE FUSE OR TABLE FOR AMP RATING CAUTION: FOR CORRECT PROTECTION AGAINST RISK OF FIRE, REPLACE ONLY WITH SAME TYPE FUSE WITH IDENTICAL ELECTRICAL RATING	
Strom Pinball® Inc. (2008) 820-6344 CD Rev. 0	

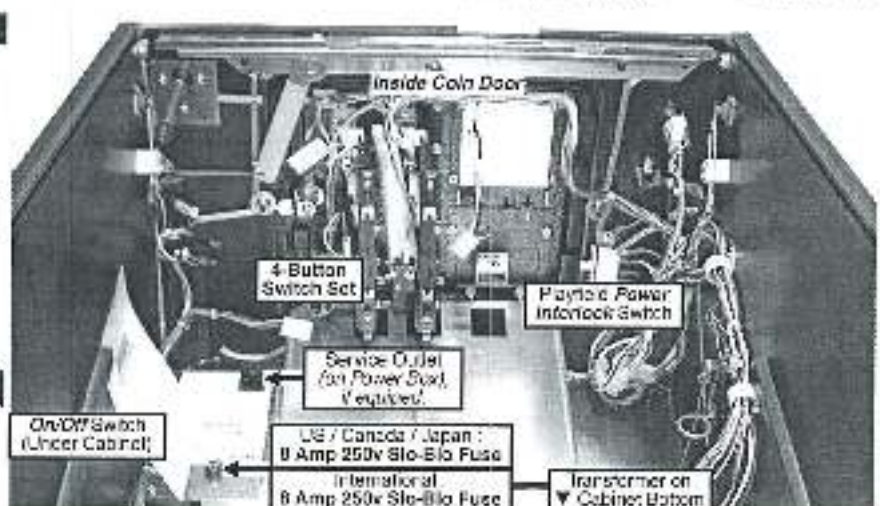
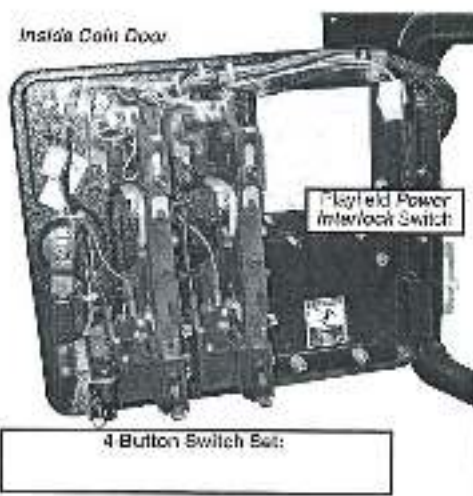

OPEN THE COIN DOOR TO ACCESS THE SERVICE SWITCH X4 SET.

● ● ● ● Service Switch X4 Set Overview

The four buttons (inside Coin Door) have dual functions depending if you have entered the Service Menu or not.

Functions in Game or Attract Mode



- Green Button
Press for Service Credit(s).
- Red Buttons
Press for Volume Adjustment
- for less (quieter),
+ for more (louder).
- Black Button
Press for Service Menu entry.

Functions in the Service Menu



- Green Button
Press to Escape Back (or Exit).
- Red Buttons
Press to move < Left, Right >.
Press to - Decrease or + Increase values or to change settings.
- Black Button
Press to Enter Select (or 'OK').

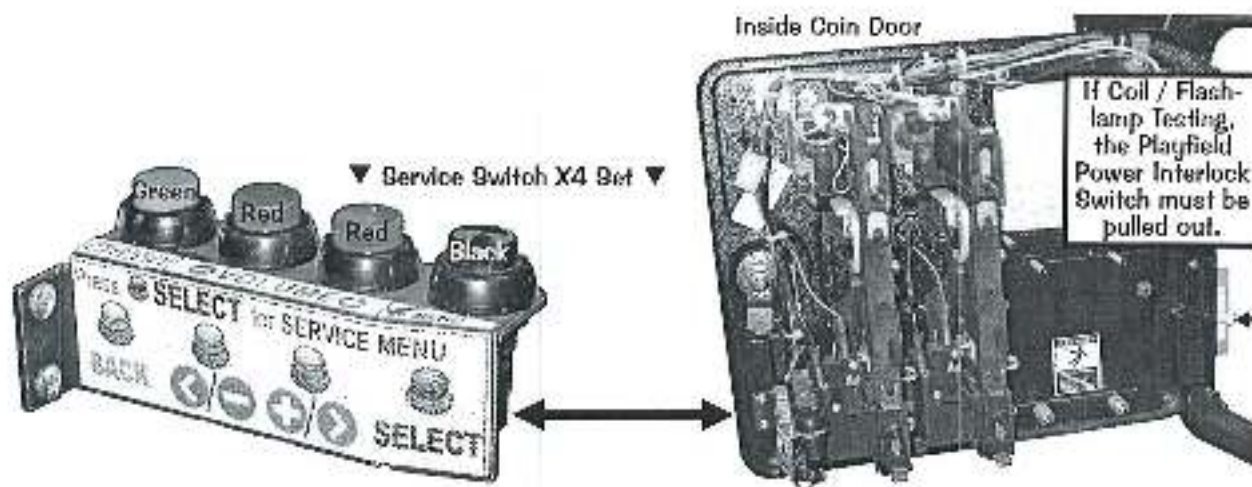

EXAMPLE:

To enter the **SERVICE MENU**, then enter the **SWITCH TEST MENU** via the **DIAGNOSTIC MENU**, perform the below steps.

Step 1 Press [SELECT].

Step 2 With the "DIAG" icon highlighted, press [SELECT].

Step 3 With the "SW" icon highlighted, press [SELECT].

Step 4 With the "TEST" icon highlighted, press [SELECT].

Press any switch. If wired correctly, the information in the display will match the information in the Switch Matrix (see DR. 4).

Press [<] or [>] to move left or right through the menus.

Press [BACK] to go back a menu, exit or escape at any time.

Continue through the other menus.



The Service Menu is subject to change. Update this game with the latest code downloaded from our website with a USB Data Storage Device (64MB min., recommendation 128MB or higher). See the inside front cover for directions or in the Service Menu "Go To Utilities Menu" then "Go To USB Menu" and follow prompts.

DIAGNOSTIC AIDS

50V / 20V DISABLED
CLOSE COIN DOOR
OR PULL INTERLOCK SWITCH
TO RESTORE POWER

This **audible / visual alert display** is shown when the 50V / 20V Power is disabled (by opening the Coin Door). **PULL OUT THE INTERLOCK SWITCH ONLY WHILE IN THE SERVICE MENU FOR COIL, SWITCH OR PLAY TESTING WHEN THE COIN DOOR IS REQUIRED TO STAY OPEN FOR SERVICE BUTTON USE!** Pulling out the Power Interlock Switch or pressing the

'escape' Green [**BACK**] Button will remove the alert display. Initial display presentation is accompanied by 3 audible tones (the bright display warning will go dim after approximately 30 seconds).

OPERATOR ALERT!
AUTO PLUNGER
DEVICE MALFUNCTION

This **alert display** is shown momentarily during **Game Mode** or **Power-Up** to alert the operator of a device malfunction (device or mechanism doesn't energize or is energized repeatedly).

OPERATOR ALERT! works by monitoring any switch activated device that has the potential to trap a ball when disabled (e.g. in the Shooter Lane, Scoop or Eject Holes, etc.). This alert can also appear if a switch associated with a device (e.g. Ball Trough, Auto Plunger, etc.) is stuck closed (caused by a switch jam or stuck ball); the game will activate the device a predetermined number of times and if the problem is still detected, this device or switch will be noted in **Switch Alerts** and/or **Technician Alerts**.

V0.00 **GAME NAME** HDW. 0
SYS. 0.00
SERVICE MENU *
USE -/+ TO VIEW TECH. ALERTS

Upon entering the **SERVICE MENU**, if an asterisk '*' is displayed after the words 'SERVICE MENU,' the game has detected possible faulty devices, switches and/or missing pinballs. Press the either of the **Red Buttons** (short-cut to the **TECHNICIAN ALERTS MENU**) or continue into the **SERVICE MENU** (press the **Black Button** again), select the "DIAG" icon and 'TECH' icon for the Technician Alerts information.

CPU DIP SWITCH SETTINGS

The 8-Pos. Dip Switch [SW1] is on the CPU/Sound Board (between Conn. J3 & J13, lower left corner)

CPU COUNTRY SETTING:	Pos.	1	2	3	4	5	6	7	8
USA	ON								
	OFF	▲	▲	▲	▲	▲	▲	▲	▲

CPU COUNTRY SETTING:	Pos.	1	2	3	4	5	6	7	8
Germany	ON	▲	▲	▲	▲	▲	▲	▲	▲
	OFF								

CPU COUNTRY SETTING:	Pos.	1	2	3	4	5	6	7	8
Russia	ON	▲	▲	▲	▲	▲	▲	▲	▲
	OFF								

CPU COUNTRY SETTING:	Pos.	1	2	3	4	5	6	7	8
Australia	ON	▲	▲	▲	▲	▲	▲	▲	▲
	OFF								

CPU COUNTRY SETTING:	Pos.	1	2	3	4	5	6	7	8
Greece	ON	▲	▲	▲	▲	▲	▲	▲	▲
	OFF								

CPU COUNTRY SETTING:	Pos.	1	2	3	4	5	6	7	8
So. Africa	ON	▲	▲	▲	▲	▲	▲	▲	▲
	OFF								

CPU COUNTRY SETTING:	Pos.	1	2	3	4	5	6	7	8
Austria	ON	▲	▲	▲	▲	▲	▲	▲	▲
	OFF								

CPU COUNTRY SETTING:	Pos.	1	2	3	4	5	6	7	8
Italy	ON	▲	▲	▲	▲	▲	▲	▲	▲
	OFF								

CPU COUNTRY SETTING:	Pos.	1	2	3	4	5	6	7	8
Spain	ON	▲	▲	▲	▲	▲	▲	▲	▲
	OFF								

CPU COUNTRY SETTING:	Pos.	1	2	3	4	5	6	7	8
Belgium	ON	▲	▲	▲	▲	▲	▲	▲	▲
	OFF								

CPU COUNTRY SETTING:	Pos.	1	2	3	4	5	6	7	8
Japan	ON	▲	▲	▲	▲	▲	▲	▲	▲
	OFF								

CPU COUNTRY SETTING:	Pos.	1	2	3	4	5	6	7	8
Sweden	ON	▲	▲	▲	▲	▲	▲	▲	▲
	OFF								

CPU COUNTRY SETTING:	Pos.	1	2	3	4	5	6	7	8
Canada 1	ON	▲	▲	▲	▲	▲	▲	▲	▲
	OFF								

CPU COUNTRY SETTING:	Pos.	1	2	3	4	5	6	7	8
Lithuania	ON	▲	▲	▲	▲	▲	▲	▲	▲
	OFF								

CPU COUNTRY SETTING:	Pos.	1	2	3	4	5	6	7	8
Switzerland	ON	▲	▲	▲	▲	▲	▲	▲	▲
	OFF								

CPU COUNTRY SETTING:	Pos.	1	2	3	4	5	6	7	8
Canada 2	ON	▲	▲	▲	▲	▲	▲	▲	▲
	OFF								

CPU COUNTRY SETTING:	Pos.	1	2	3	4	5	6	7	8
Middle East	ON	▲	▲	▲	▲	▲	▲	▲	▲
	OFF								

CPU COUNTRY SETTING:	Pos.	1	2	3	4	5	6	7	8
Taiwan	ON	▲	▲	▲	▲	▲	▲	▲	▲
	OFF								

CPU COUNTRY SETTING:	Pos.	1	2	3	4	5	6	7	8
Croatia	ON	▲	▲	▲	▲	▲	▲	▲	▲
	OFF								

CPU COUNTRY SETTING:	Pos.	1	2	3	4	5	6	7	8
Netherlands	ON	▲	▲	▲	▲	▲	▲	▲	▲
	OFF								

CPU COUNTRY SETTING:	Pos.	1	2	3	4	5	6	7	8
UK	ON	▲	▲	▲	▲	▲	▲	▲	▲
	OFF								

CPU COUNTRY SETTING:	Pos.	1	2	3	4	5	6	7	8
Denmark	ON	▲	▲	▲	▲	▲	▲	▲	▲
	OFF								

CPU COUNTRY SETTING:	Pos.	1	2	3	4	5	6	7	8
New Zealand	ON	▲	▲	▲	▲	▲	▲	▲	▲
	OFF								

CPU COUNTRY SETTING:	Pos.	1	2	3	4	5	6	7	8
UPDATE CODE	ON	▲	▲	▲	▲	▲	▲	▲	▲
	OFF								

CPU COUNTRY SETTING:	Pos.	1	2	3	4	5	6	7	8
Finland	ON	▲	▲	▲	▲	▲	▲	▲	▲
	OFF								

CPU COUNTRY SETTING:	Pos.	1	2	3	4	5	6	7	8
Norway	ON	▲	▲	▲	▲	▲	▲	▲	▲
	OFF								

CPU COUNTRY SETTING:	Pos.	1	2	3	4	5	6	7	8
France	ON	▲	▲	▲	▲	▲	▲	▲	▲
	OFF								

CPU COUNTRY SETTING:	Pos.	1	2	3	4	5	6	7	8
Portugal	ON	▲	▲	▲	▲	▲	▲	▲	▲
	OFF								

Note: Slide Dip Switch 8 to Position ON (with Dip Switches 1-7 in the OFF Position) only to reboot the game with the latest version BOOT EPROM installed at U9 on the CPU/Sound Board (S.A.M. System only). Currently, this is also the procedure to update your game with the latest software code update file. For the latest version, visit our website. If you have questions about updating your game code, call Technical Support for assistance.

Pinball Service Menu Icon Tree Continued

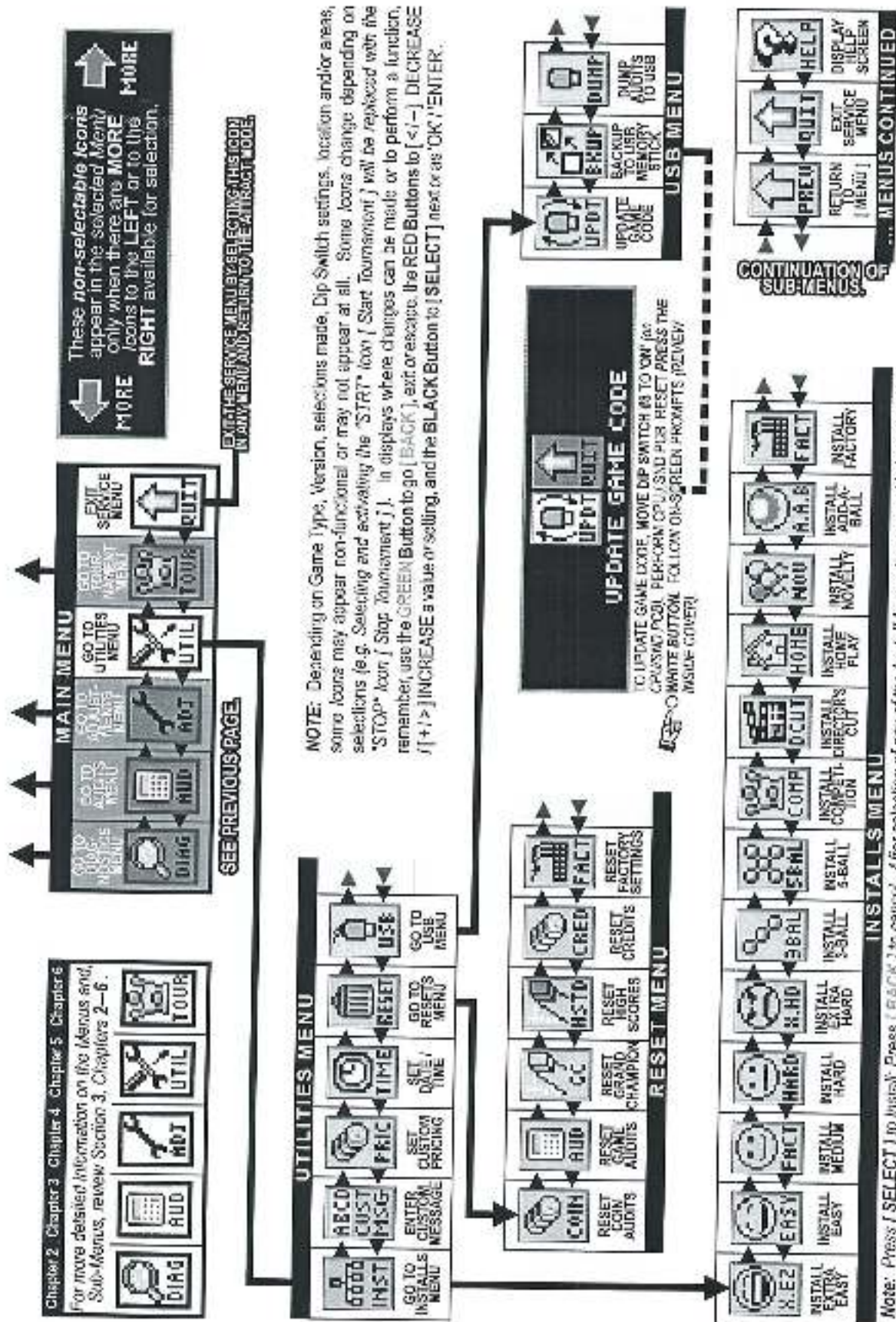

These non-selectable icons appear in the selected Menu only when there are MORE icons to the LEFT or to the RIGHT available for selection.

EXIT THE SERVICE MENU BY SELECTING THIS ICON IN ANY MENU AND RETURN TO THE ATTRACT MODE.

NOTE: Depending on Game Type, Version, selections made, Dip Switch settings, location and/or areas, some icons may appear non-functional or may not appear at all. Some icons change depending on selections (e.g. Selecting and activating the "START" icon [Start Tournament] will be replaced with the "STOP" icon [Stop Tournament]). In displays where changes can be made or to perform a function, remember, use the GREEN Button to go [BACK], exit or escape; the RED Buttons to [←] DECREASE [→] INCREASE a value or setting, and the BLACK Button to [SELECT] next or as 'OK' / 'ENTER'.

Service Menu Introduction

Important: The **Switch Bracket** holds the **Playfield Power Interlock**. It is located just inside the **Coin Door** frame (see pictorial of the **Coin Door** on the previous page). The **Button Switch** for the **Playfield Power Interlock Switch** must be pulled out for electro-mechanical device testing or diagnostic purposes (this is required). If this button is pushed in, the **Playfield Power** is disabled while the **Coin Door** is **OPEN**.

To get into the **SERVICE MENU MODE** review "**Function 3: SERVICE MENU**" on the next page. After **Power-Up**, push down the **Black [SELECT]** Button to begin. Looking at the display you will momentarily see '**SERVICE MENU**' followed by the **MAIN MENU**:



Use the **Red [</-] / [+ / >]** Buttons to move the selected **Icon** left or right, and the **Black [SELECT]** Button to activate the selected **Icon**.

The **MAIN MENU** now appears with the '**DIAG**' **Icon** (**GO TO DIAGNOSTICS MENU**) highlighted:



As the operator views the Menu Screen(s), the **← MORE MORE →** symbols indicates that there are more **Icons** to select in each direction. The **Icon** selected will blink. Pushing the **Black [SELECT]** Button will select the **Icon** and the Menu Screen will change to the menu selected. Select the **Green [BACK]** Button to move backwards through the menu levels. Press the **Green [BACK]** Button repeatedly or select the "**QUIT**" **Icon** to completely exit the **SERVICE MENU** Mode.

View the **SERVICE MENU Icon Tree** on the next pages for a complete overview of all menus used in this system. The '**HELP**' **Icon** provides an explanation of **ICON** usage or any other information in the Menu where the "**HELP**" **Icon** was selected (when available).

DIAG: GO TO DIAGNOSTICS MENU

AUD: GO TO AUDITS MENU

ADJ: GO TO ADJUSTMENTS MENU

UTIL: GO TO UTILITIES MENU

(INSTALLS, CUSTOM MSG., CUSTOM PRICING, SET TIME, RESET & USB)

TOUR: GO TO TOURNAMENT MENU (START TOURNAMENT, VIEW TOURNAMENT DATA, SIGN MESSAGES)

>> TO UPDATE THE GAME CODE, REVIEW THE STEPS ON THE INSIDE FRONT COVER OF THIS MANUAL.

Use both the manual and the display to help customize, troubleshoot and/or diagnose faults, if any.





Exit Service Menu

In the **MAIN MENU** and in all **SUB-MENUS** (where the "QUIT" icon is present), if the "QUIT" icon is selected and activated, or the **Green [BACK] Button** is selected repeatedly (depending on which sub-menu you're in...), the **SERVICE MENU** Session will be exited and returned to the **Attract Mode**.



Turning the game on/off will start the **Power-Up Routine**. Upon **Power-Up**, the **DISPLAY** will indicate the **COUNTRY, FILE VERSION** and **LANGUAGE(S)** installed. **LANGUAGE/COUNTRY**: change via Dip Switch.



The below **Problem / Solution Table** was designed to answer some common problems frequently asked.

Problem / Solution Table

PROBLEM	SOLUTION
Will not enter the SERVICE MENU after depressing the Black [SELECT] Button .	<ul style="list-style-type: none"> • Check the Service Switches [GREEN, RED pg; & BLACK Buttons] for loose connections or bad ground. • Check the associated wiring harness to/from the CPU/Sound Board, Connector J13. • Check CPU/Sound Board for possible failure.
All Service Buttons [- * * Buttons] appear nonfunctional.	<ul style="list-style-type: none"> • Check the Service Switches wiring harness for poor or no connection and/or broken wires.
The Green Button in the Attract Mode will not enter the SERVICE CREDITS MENU to add Service Credits .	<ul style="list-style-type: none"> • Check to make sure the Game is not in "Free Play." If the game is set to Free Play, adding Service Credits is not required. • Check the Service Switches wiring harness for poor or no connection and/or broken wires.
The Display "blinks out."	<ul style="list-style-type: none"> • Check the Dot Matrix Display for loose wiring harness for poor or no connection and/or broken wires. • Check F1 (34A Fuse) on the Display Power Supply Board. Refer to the Yellow Pages [SCHEMATICS & TROUBLESHOOTING].
Icons "scroll" along continuously in the MAIN MENU .	<ul style="list-style-type: none"> • Check for a stuck switch on either of the Red Buttons.
The Start and Flipper Buttons do not select or activate icons in the SWITCH TEST MENU .	<ul style="list-style-type: none"> • This is normal. These switches are deactivated, as they are a part of the Switch Test. Refer to the Diagnostics Section [GO TO DIAGNOSTICS MENU, Switch Test].
Can't move selection of icon with the Left and/or Right Flipper Buttons .	<ul style="list-style-type: none"> • Check the Flipper Buttons for loose connections or bad Ground and refer to Section 5, Chapter 2, Playfield Wiring, 4-Flipper Circuit Wiring Diagram. • This is normal <i>only in Diagnostic's Switch & Active Switch Tests</i> (see previous Problem).
Some icons appear non-functional in the MENU or missing.	<ul style="list-style-type: none"> • Some functionality of the Service Menu may not have been completed during development. If exists, it should only be a non-critical function, such as the "HELP" icon, which will explain the usage of icons. When completed, a software update will correct the problem. Software updates are announced via Service Bulletins (if critical) and on our website http://www.sternpinball.com/GAME-code.shtml; view the Game Code Library Message Board Marquee or click Previous Messages for past announcements.
In COIL TEST MENU , the coils and flashlamps do not fire after pressing the Black [SELECT] Button .	<ul style="list-style-type: none"> • Ensure the POWER INTERLOCK SWITCH is pulled out (see the start of this Chapter).
In the SERVICE MENU , the volume cannot be adjusted with either of the Red Buttons .	<ul style="list-style-type: none"> • The Volume adjustment can only be made when in the Attract Mode (see the start of this Chapter).
In the SERVICE MENU , the display seems to lock up, or the Help Display appears to be non-functional.	<ul style="list-style-type: none"> • If you cannot clear the situation by exiting back one Menu, exit completely out of the SERVICE MENU, and re-enter. If the problem persists, call Technical Support for additional help.

IF YOU NOTE ANY OTHER PROBLEMS OR HAVE ANY SYMPTOMS NOT DESCRIBED ABOVE, PLEASE CALL TECHNICAL SUPPORT 800-542-5377 (708-345-7700 OPTION #1), SO WE MAY ASSIST YOU.



To initiate, from the **MAIN MENU**, select the "DIAG" icon. The **DIAGNOSTICS MENU** provides tests for switches, coils, flash lamps, lamps, sounds and dots in the Dot Matrix Display. Each feature may be tested manually or automatically after entering the **SERVICE MENU** (see *Service Menu Introduction Section*).

The [**CYCLING COIL TEST**] / [**FLASH LAMP TEST**] may be used for a quick verification of automatic test functions. The [**SWITCH TEST**] / [**SINGLE COIL TEST**] / [**SINGLE LAMP TEST**] / [**ALL LAMPS TEST**] / [**ROW LAMPS TEST**] / [**COLUMN LAMPS TEST**] / [**FLASH LAMP TEST**] may be used for troubleshooting.

All **DIAGNOSTICS MENU** icons and their usages are explained throughout this chapter in the same order as seen in the Dot Matrix Display. **NOTE:** Depending on Game Type, Version, selections made, Dip Switch settings, location and/or areas, some icons may appear non-functional or may not appear at all. Some icons change depending on selections (e.g. *Selecting and activating the "START" icon [Start Tournament] will be replaced with the "STOP" icon [Stop Tournament]*). **Icons and/or functions, order and operation are subject to change.**

In displays where changes can be made or to perform a function, use the **GREEN Button** to go [**BACK**], exit or escape, the **RED Buttons** to [**< / -**] **MOVE BACK / LEFT / DECREASE** / [**+ / >**] **MOVE FORWARD / RIGHT / INCREASE** a value or setting, and the **BLACK Button** to [**SELECT**] next or as "OK / ENTER / ENERGIZE."

Important: Upon Power-Up (Game CPU Reset) or opening the **Coin Door** watch the Display for any Alerts.*

50V / 20V DISABLED
CLOSE COIN DOOR
OR PULL INTERLOCK SWITCH
TO RESTORE POWER

This **audible / visual alert display** is shown when the 50V / 20V Power is disabled (by opening the Coin Door). **PULL OUT THE INTERLOCK SWITCH ONLY WHILE IN THE SERVICE MENU FOR COIL OR SWITCH TESTING & BURN-IN WHEN THE COIN DOOR IS REQUIRED TO STAY OPEN FOR SERVICE BUTTON USE!** Pulling out the Power Interlock Switch or

pressing the 'escape' Green [**BACK**] Button will remove the alert display. Initial display presentation is accompanied by 3 audible tones (the bright display warning will go dim after approximately 30 seconds).

OPERATOR ALERT!
AUTO PLUNGER
DEVICE MALFUNCTION

This **alert display** is shown momentarily during **Game Mode** or **Power-Up** to alert the operator of a device malfunction (device or mechanism doesn't energize or is energized repeatedly).

OPERATOR ALERT! works by monitoring any switch activated device that has the potential to trap a ball when disabled (e.g. in the Shooter Lane, Scoop or Eject Holes, etc.). This alert can also appear if a switch associated with a device (e.g. Ball Trough, Auto Plunger, etc.) is stuck closed (caused by a switch jam or stuck ball); the game will activate the device a predetermined number of times and if the problem is still detected, this device or switch will be noted in **Switch Alerts** (next page) and/or **Technician Alerts**.

00.00 GAME NAME
SYS. 0.00 HDW. 0
SERVICE MENU *
USE -/+ TO VIEW TECH. ALERTS

Upon entering the **SERVICE MENU**, if an asterisk "*" is displayed after the words "SERVICE MENU," the game has detected possible faulty devices, switches and/or missing pinballs. Press the either of the **Red Buttons** (short-cut to the **TECHNICIAN ALERTS MENU**) or continue into the **SERVICE MENU** (press the **Black Button** again), select the "DIAG" icon and "TECH" icon for the **Technician Alerts** information.



CAUTION! Remove all pinballs from the Ball Trough prior to lifting the playfield to its full upright position for servicing. **PULL OUT the Power Interlock Switch** for operation. To eject pinballs, select the "DIAG" icon from the **MAIN MENU** to enter the **DIAGNOSTICS MENU**. Select the "CLR" icon to enter the **BALL TROUGH TEST MENU**. Press the **Black [SELECT] Button**. To return to the **DIAGNOSTICS MENU**, press the **Green [BACK] Button**. This feature also useful to retrieve a pinball for game testing in **Switch or Coil Tests**.



Go To Switch Menu

To initiate, from the **DIAGNOSTICS MENU**, select the "SW" icon. Switches are configured in an 4 X 16 Matrix of Rows [Switch Drives] and Columns [Sw. Returns] with up to 64 possible switches. Dedicated Switches are configured in a 2 X 16 Matrix of Rows [Dedicated Sw. Drives / Ground] and Column [Ded. Switch Returns] with up to 32 possible dedicated switches (includes the 8 dip switch positions). The **SWITCH TEST MENU** consists of three (3) parts: **Switch & Active Switch Tests** and **Switch Alerts** to test *all* switches.

Reminder: The Flipper & Start Buttons (part of Switch Tests) are temporarily disabled as Service Menu Navigation Buttons during these test(s) so they can be tested and shown on-screen. Pressing the Green [BACK] Button (Dedicated Switch D-21), Light Green-Black / Black (GND), will exit Switch Test or Active Switch Test.



Switch Test

To initiate, from the **SWITCH MENU**, select the "TEST" icon. Ensure the **Power Interlock Switch** is pulled out if testing with the Coin Door open and the activation of coils is required. Upon entering **Switch Test**, you will notice that some switches are already indicated as closed. In the examples, the 4-Ball Trough Switches #18, #19, #20 & #21 are shown closed (pinballs at rest in the ball trough), along with the Flipper E.O.S. Dedicated Switches D-10 & D-12 (End-of-Stroke Switches are 'normally closed'). If the game has more flippers with E.O.S. Dedicated Switches, CPU Dip Switch Setting other than 1-8 OFF or switches stuck closed, more dots will be indicated (enter **Active Switch Test** to reveal the names).

In **Switch Test**, close each switch and observe the display (switch closure is accompanied by a short audible tone). In the example, the **Black [SELECT] Button** Dedicated Switch D-24 is pressed. The Dot Matrix Display will light up (highlight) the corresponding dot in the on-screen matrix, display the switch name, switch number and the Switch Drive / Return wire colors. When not closing a switch, the display indicates **NONE** and the last switch number closure. For the Switch Matrix Grid and Dedicated Switch Grid, see Find-It-In-Front: Dr. Pinball, DR. 4 or escape out of this test and enter **Active Switch Test** (described below) to view the names of the switches closed. *Note: Pressing the Green [BACK] Button (Ded. Switch D-21), Lt. Green-Black / Black (GND), will exit the Switch Test.*

CAUTION! COIL MECHANISMS WHEN ACTIVATED HAVE FAST MOVING PARTS! While performing **Switch Test** with the Coin Door closed or open (with the **Power Interlock Switch** is pulled out), **DO NOT USE YOUR FINGER** to test switches which are associated with a coil mechanism such as a Vertical Up-Kicker (hole with a switch), Slingshots, Bumpers, etc..



Active Switch Test

To initiate, from the **SWITCH MENU**, select the "ACT" icon. In **Active Switch Test**, if any switches are stuck closed (or normally closed from the presence of pinball(s) as in the Ball Trough), the display will flash the corresponding dot(s) in the on-screen matrix, display the name and the Switch Drive / Return wire colors. If more than one switch is closed, the switch information will change with each switch. This cycle continues until all switches are cleared or until **Active Switch Test** is exited. In the example, the **Black [SELECT] Button** Dedicated Switch D-24 is pressed and held down. The display will cycle and flash each dot, naming each switch which is closed. To determine the switch number, compare the highlighted dot to the same position in the Switch Matrix Grid at the beginning of this manual.



Switch Alerts

To initiate, from the **SWITCH MENU**, select the "ALRT" icon. In **Switch Alerts Menu**, possible inoperable switches are marked with an "X" (OUT OF SERVICE). Mark switches **IN** or **OUT OF SERVICE** by pressing the **Black Button** while the intended switch is highlighted and change with either of the **Red Buttons**. Switches which are determined as "OUT OF SERVICE" by the game or manually, will be automatically marked as "IN SERVICE" as soon as the game determines a valid switch closure (after adjusting, fixing or replacing the switch, then testing/actuating the switch). *Note: A Factory Reset will also put the switch back "IN SERVICE" in which the game will need to redetermine if the switch should be marked OUT OF SERVICE.*

Upon entering Switch Test, you will notice that some switches are already indicated as closed.



Upon pressing the [SELECT] Button, the display will indicate the last switch number.



After pressing the switch, the display will indicate the switch name.



Typical Switch Wiring & Schematic

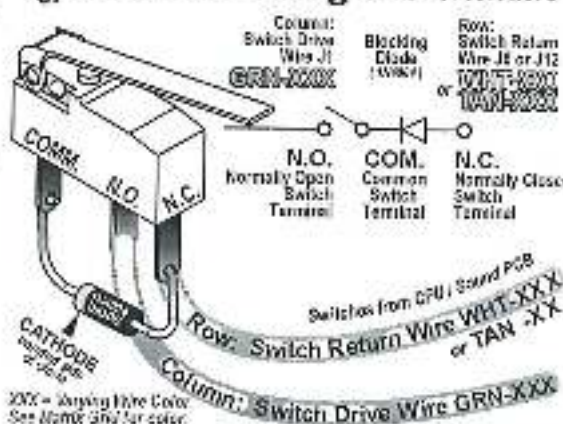

Dedicated Switch Schematic



Upon pressing the [SELECT] Button, the display will indicate the last switch number.



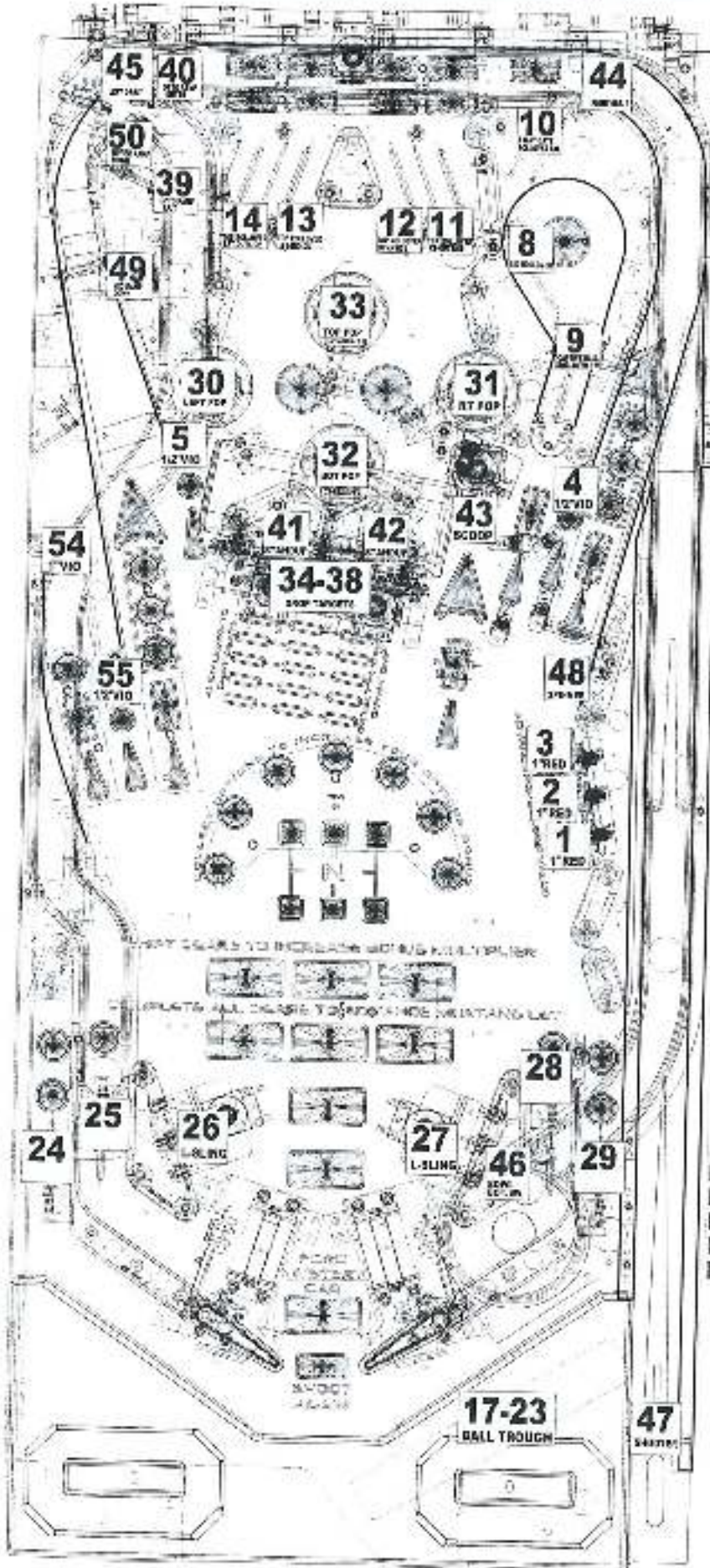

Typical Switch Wiring & Schematic

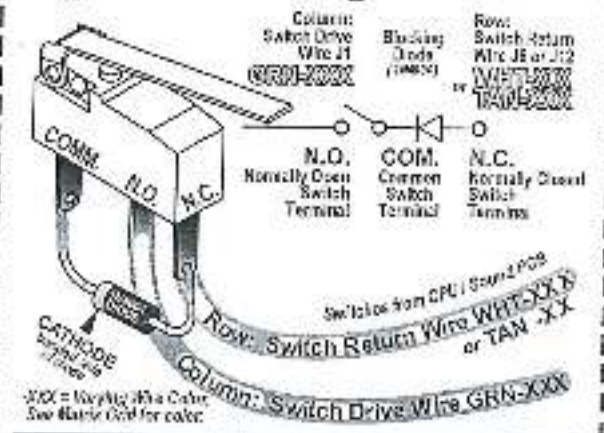

Dedicated Switch Schematic

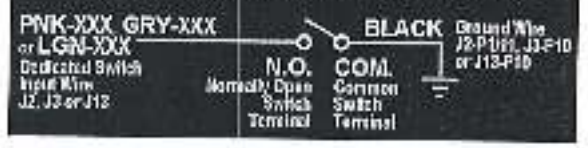

Typical Switch Wiring & Schematic ... with Switch Diode on a Terminal Strip (DOTS)

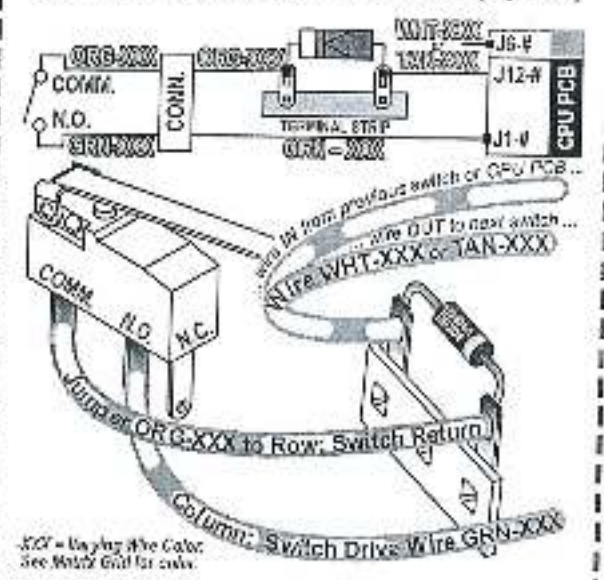



Go To Coil Menu

To initiate, from the **DIAGNOSTICS MENU**, select the "COIL" icon. Coils #01 – #16 are typically High Current Coils (although Low Current Coils may be used in these positions & will be noted). Coils #17 – #32 are typically Low Current Coils. Flash Lamps are typically used in positions #25 – #32 (although Flash Lamps may be used in any position and will be noted). Auxiliary Coils may be used in positions #33 – #35.

Remember, use the **GREEN Button** to go [**BACK**], exit or escape, the **RED Buttons** to [**< / -**] GO BACK [**+ / >**] GO FORWARD, and the **BLACK Button** to [**SELECT**] ENERGIZE the coil (solenoid) or flash lamp.



Single Coil Test

To initiate, from the **COIL MENU**, select the "TEST" icon. Ensure the **Power Interlock Switch** is pulled out if testing with the Coin Door open. Upon entering **Single Coil Test**, you will notice the #1 coil is shown. The Dot Matrix Display will indicate the coil or flash lamp name, coil (solenoid) or flash lamp number and the Coil or Flash Lamp Power Line / Drive Transistor Control Line wire colors. To determine the "Pin-Outs" from the I/O Power Driver Board, the Coil Voltage Gauge-Turns (e.g. 23-800) or lamp type (e.g. #89 or #906 Bulb), view the Coils Detailed Chart Table at the beginning of this manual or for more on troubleshooting and diagnosing, see the Yellow Pages (Schematics & Wiring).



Cycling Coil Test

To initiate, from the **COIL MENU**, select the "CYC" icon. Ensure the **Power Interlock Switch** is pulled out if testing with the Coin Door open. The test pulses each regular coil or flash lamp sequentially (cycling) on the Playfield and in the Backbox (if coils or flash lamps are used). The Dot Matrix Display indicates the same information you will find in **Single Coil Test**.

COIL TEST
TROUGH UP-KICKER
#1
YEL-VIO BRN-BLK

Typical Coil Wiring & Schematic

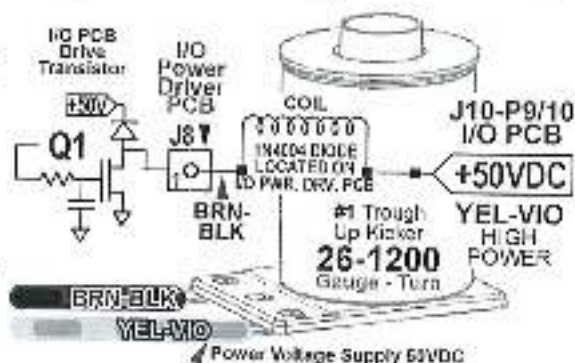

Go To Flash Lamps Menu

To initiate, from the **DIAGNOSTICS MENU**, select the "FLASH" icon. The two tests allows the technician to easily spot any burned-out flash lamps and replace them. Unlike **Single Coil Test**, which tests all coil (solenoids), including flash lamps, **Single and Cycling Flash Lamp Tests**, test only the flash lamps used in the game. Flash Lamps are typically used in positions #25 – #32 (although Flash Lamps may be used in any position and will be noted).

Remember, use the **GREEN Button** to go [**BACK**], exit or escape, the **RED Buttons** to [**< / -**] GO BACK [**+ / >**] GO FORWARD, and the **BLACK Button** to [**SELECT**] ENERGIZE the flash lamp.



Single Flash Lamp Test

To initiate, from the **FLASH LAMPS MENU**, select the "TEST" icon. Ensure the **Power Interlock Switch** is pulled out if testing with the Coin Door open. Upon entering **Single Flash Lamp Test**, you will notice the first Flash Lamp is shown. The Dot Matrix Display will indicate the flash lamp name, flash lamp number and the Flash Lamp Power Line / Drive Transistor Control Line wire colors. To determine the "Pin-Outs" from the I/O Power Driver Board or lamp type (e.g. #89 or #906 Bulb), view the Coils Detailed Chart Table at the beginning of this manual or for more on troubleshooting and diagnosing, see the Yellow Pages (Schematics & Wiring).



Cycling Flash Lamp Test

To initiate, from the **FLASH LAMPS MENU**, select the "CYC" icon. Ensure the **Power Interlock Switch** is pulled out if testing with the Coin Door open. The test pulses each flash lamp sequentially (cycling) on the Playfield and in the Backbox (if flash lamps are used). The Dot Matrix Display indicates the same information you will find in **Single Flash Lamp Test**.

FLASH LAMP TEST
FLASH: NAME OF FLASHER
#25
ORG BLK-BRN

Bulb Types used for Flash Lamps

#906 Bulb
(Wedge Base)
185-5004-00



#89 Bulb
(Bayonet)
185-5004-00-11P



COILS DETAILED CHART TABLE

High Current Coils Group 1		Drive Transistor	Driver Output PCB	Power Line Color	Power Line Connection	Power Voltage	Drive Transistor Control Line Color	D.T. Control Line Connect	Coil GA-Turn or Bulb Type
#1	TROUGH UP-KICKER	Q1	▲ I/O Power Driver ▼	YEL-VIO	J10-P8/10	50VDC	BRN-BLK	J8-P1	25-1200 000-5000-06
#2	AUTO LAUNCH	Q2		YEL-VIO	J10-P9/10	50VDC	BRN-RED	J8-P3	23-300 000-5001-06
#3	MID RAMP	Q3		YEL-VIO	J10-P6/10	50VDC	BRN-ORG	J8-P4	25-1000 000-5000-06
#4	MID RAMP HOLD POWER	Q4		YEL-VIO	J10-P8/10	50VDC	BRN-YEL	J8-P5	25-1000 000-5000-06
#5	UPPER RAMP	Q5		YEL-VIO	J10-P9/10	50VDC	BRN-GRN	J8-P6	23-1000 000-5000-06
#6	UPPER RAMP HOLD POWER	Q6		YEL-VIO	J10-P9/10	50VDC	BRN-BLU	J8-P7	25-1000 000-5000-06
#7	CENTER 5- BANK DROP RESET	Q7		YEL-VIO	J10-P8/10	50VDC	BRN-VIO	J8-P8	25-1000 000-5000-06
#8	SHAKER MOTOR (OPTIONAL)	Q8		RED-WHT	J17-P7	16VAC	BRN-GRY	J8-P9	000-5000-00
High Current Coils Group 2		Drive Transistor	Driver Output PCB	Power Line Color	Power Line Connection	Power Voltage	Drive Transistor Control Line Color	D.T. Control Line Connect	Coil GA-Turn or Bulb Type
#9	LEFT POP BUMPER	Q9	▲ I/O Power Driver ▼	YEL-VIO	J10-P8/10	50VDC	BLU-BRN	J9-P1	25-1200 000-5000-06
#10	RIGHT POP BUMPER	Q10		YEL-VIO	J10-P9/10	50VDC	BLU-RED	J9-P2	23-1000 000-5000-06
#11	BOTTOM POP BUMPER	Q11		YEL-VIO	J10-P9/10	50VDC	BLU-ORG	J9-P4	25-1200 000-5000-06
#12	TOP POP BUMPER	Q12		YEL-VIO	J10-P9/10	50VDC	BLU-YEL	J9-P5	25-1000 000-5000-06
#13	LEFT SLINGSHOT	Q13		YEL-VIO	J10-P9/10	50VDC	BLU-GRN	J9-P6	25-1200 000-5000-06
#14	RIGHT SLINGSHOT	Q14		YEL-VIO	J10-P9/10	50VDC	BLU-BLU	J9-P7	25-1200 000-5000-06
#15	LEFT FLIPPER (50V RED/YEL)	Q15		GRY-YEL-3A Fuse-RED-YEL	J10-P6/7	50VDC	ORG-GRY	J9-P8	25-800 000-5000-06
#16	RIGHT FLIPPER (50V RED/YEL)	Q16		BLU-YEL-3A Fuse-RED-YEL	J10-P6/7	50VDC	ORG-VIO	J9-P9	25-1000 000-5000-06
Low Current Coils Group 1		Drive Transistor	Driver Output PCB	Power Line Color	Power Line Connection	Power Voltage	Drive Transistor Control Line Color	D.T. Control Line Connect	Coil GA-Turn or Bulb Type
#17	FLASH: LEFT ORBIT ARROW	Q17	▲ I/O Power Driver ▼	ORG	J6-P10	20VDC	VIO-BRN	J7-P2	LED 113-5034-08
#18	FLASH: RIGHT ORBIT ARROW	Q18		ORG	J6-P10	20VDC	VIO-RED	J7-P3	LED 113-5034-08
#19	FLASH: SLINGSHOT (LEFT)	Q19		ORG	J6-P10	20VDC	VIO-ORG	J7-P4	LED 113-5034-08
#20	FLASH: SLINGSHOT (RIGHT)	Q20		ORG	J6-P10	20VDC	VIO-YEL	J7-P6	LED 113-5034-08
#21	FLASH: BACK PANEL (LEFT)	Q21		ORG	J6-P10	20VDC	VIO-GRN	J7-P7	LED 113-5034-08
#22		Q22					VIO-BLU	J7-P8	
#23	FLASH: BACK PANEL (RIGHT)	Q23		ORG	J6-P10	20VDC	VIO-BLK	J7-P9	LED 113-5034-08
#24	OPTIONAL (e.g. COIN METER)	Q24		RED	J16-P4-8	5VDC	VIO-GRY	J7-P10	COIN METER
Low Current Coils Group 2		Drive Transistor	Driver Output PCB	Power Line Color	Power Line Connection	Power Voltage	Drive Transistor Control Line Color	D.T. Control Line Connect	Coil GA-Turn or Bulb Type
#25	FLASH: POP BUMPERS (RIGHT)	Q25	▲ I/O Power Driver ▼	ORG	J6-P10	20VDC	BLK-BRN	J6-P1	LED 113-5034-00
#26	FLASH: POP BUMPERS (LEFT)	Q26		ORG	J6-P10	20VDC	BLK-RED	J6-P2	LED 113-5034-06
#27	FLASH: (RIGHT) SCOOP ARROW	Q27		ORG	J6-P10	20VDC	BLK-ORG	J6-P3	LED 113-5034-03
#28	FLASH: 180	Q28		ORG	J6-P10	20VDC	BLK-YEL	J6-P4	LED 113-5034-00
#29	FLASH: SKILLSHOT	Q29		ORG	J6-P10	20VDC	BLK-GRN	J6-P5	LED 113-5034-06
#30		Q30					BLK-BLU	J6-P6	
#31	ORBIT POST (STEP-UP DRV BD)	Q31		YEL/VIO	J10-P9/10	50VDC	BLK-VIO	J6-P7	25-1200 000-5000-06
#32	RIGHT SCOOP (STEP-UP DRV BD)	Q32		YEL/VIO	J10-P9/10	50VDC	BLK-GRY	J6-P8	25-1000 000-5000-06



Go To Lamp Menu

To initiate, from the **DIAGNOSTICS MENU**, select the 'LAMP' icon. Controlled lamps are configured in an 8 X 10 Matrix of Rows [Lamp Returns / Ground] and Columns [Lamp Drives / 18VDC] with up to 80 lamps possible. The **LAMP TEST MENU** consists of five (5) parts: **Single Lamp Test**, **Test All Lamps**, **Row Lamps Test**, **Column Lamps Test** and **Ordered Lamps Test*** to test *all* lamps.

Remember, use the **GREEN Button** to go [**BACK**], exit or escape, the **RED Buttons** to [< / -] **GO BACK / LEFT** / [+ / >] **GO FORWARD / RIGHT**, and the **BLACK Button** to [**SELECT**] next or as "OK / ENTER."

Upon entering Single Lamp Test, you will notice the #1 lamp is shown. ... Display all lamps ...



Single Lamp Test

To initiate, from the **LAMP MENU**, select the "ONE" icon. As each lamp is selected, the lamp will light at its location on the playfield as well as the Dot Matrix Display.

Display. Upon entering **Single Lamp Test**, you will notice the #1 lamp is shown. The Dot Matrix Display will light up (*highlight*) the corresponding dot in the on-screen matrix, display the *lamp name*, *lamp number* and the *Lamp Return / Drive wire colors*. For the Lamp Matrix Grid, see the beginning section of this Service Game Manual.

Upon entering All Lamps Test, you will notice the ALL LAMPS ON ...



All Lamps Test

To initiate, from the **LAMP MENU**, select the "ALL" icon. Upon entering **All Lamps Test**, you will notice the Dot Matrix Display is flashing **ALL LAMPS ON** and the lamps on the playfield will be lit, alternating between the rows in the Lamp Matrix Grid. The Dot Matrix Display will light up (*highlight*) all of the dots in the on-screen matrix.

Display. Upon entering **Row Lamps Test**, you will notice the #1 lamp row is shown. The Dot Matrix Display will light up (*highlight*) the corresponding row of dots in the on-screen matrix, display the *lamp row number*, the *Lamp Return wire colors*, the *I/O PCB Connector* and *transistor number*.

Upon entering Row Lamps Test, you will notice the #1 lamp row is shown. ...



Row Lamps Test

To initiate, from the **LAMP MENU**, select the "ROW" icon. As each lamp row is selected, the lamps in the row will light on the playfield as well as the Dot Matrix Display.

Display. Upon entering **Row Lamps Test**, you will notice the #1 lamp row is shown. The Dot Matrix Display will light up (*highlight*) the corresponding row of dots in the on-screen matrix, display the *lamp row number*, the *Lamp Return wire colors*, the *I/O PCB Connector* and *transistor number*.

Upon entering Column Lamps Test, you will notice the #1 lamp column is shown. ...



Column Lamps Test

To initiate, from the **LAMP MENU**, select the "COL" icon. As each lamp column is selected, the lamps in the column will light on the playfield as well as the Dot Matrix Display.

Display. Upon entering **Column Lamps Test**, you will notice the #1 lamp column is shown. The Dot Matrix Display will light up (*highlight*) the corresponding row of dots in the on-screen matrix, display the *lamp column number*, the *Lamp Drive (18VDC) wire colors*, the *I/O PCB Connector* and *IC number*.



Bulb Types used for Control Lamps

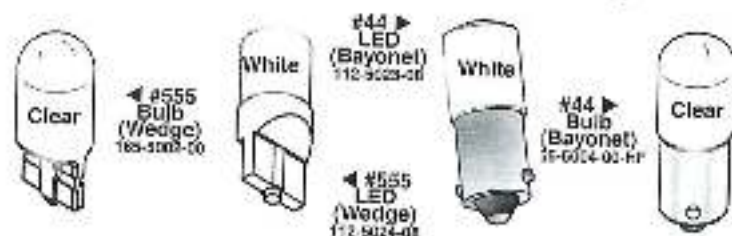

Typical Lamp Wiring & Schematic

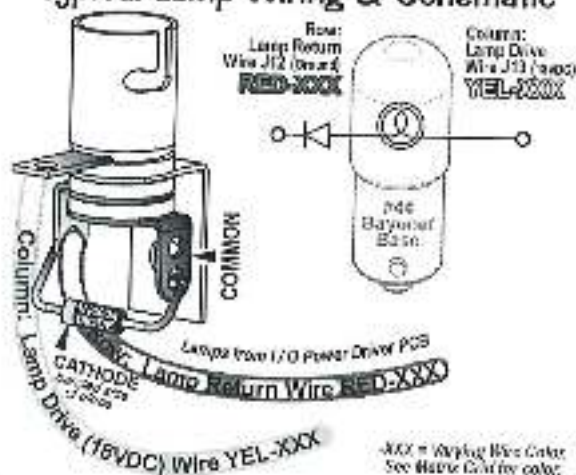

* If not required in this game, icon will not be shown.



Ordered Lamps Test

To initiate, from the **LAMP MENU**, select the "ORD" icon.

If required, this icon will appear in the LAMP MENU. Identical to **Single Lamp Test**, however, the lamps are not in the Lamp Matrix numeric order, but ordered or arranged in separate localized grouping(s) for easier lamp checking.

LAMP MATRIX GRID [#1 - #80] (Lamp Locations : next page)

I/O	01	02	03	04	05	06	07	08
Power Driver Board	IC-U17 YEL-BRN J13-P9	IC-U16 YEL-RED J13-P8	IC-U15 YEL-ORG J13-P7	IC-U14 YEL-BLK J13-P6	IC-U13 YEL-GRN J13-P5	IC-U12 YEL-BLU J13-P4	IC-U11 YEL-VIO J13-P3	IC-U10 YEL-GRY J13-P1
01	LEDC L.P. #1 LED START BUTTON	LEDC L.P. #2 LED TOURN BUTTON	LEDC L.P. #3 LED 2012 MUSTANG	LEDC L.P. #4 LED LEFT OUTLANE BOTTOM	LEDC L.P. #5 LED LEFT OUTLANE TOP	LEDC L.P. #6 LED LEFT RETURN LANE	LEDC L.P. #7 LED RIGHT RETURN LANE	LEDC L.P. #8 LED RIGHT OUTLANE TOP
02	LEDC L.P. #9 LED RIGHT OUTLANE BOTTOM	LEDC L.P. #10 LED 2015 MUSTANG	LEDC L.P. #11 LED 2015 MUSTANG	LEDC L.P. #12 LED 1968 MUSTANG	LEDC L.P. #13 LED SHOOT AGAIN	LEDC L.P. #14 LED 1970 MUSTANG	LEDC L.P. #15 LED 2011 MUSTANG	LEDC L.P. #16 LED 1965 MUSTANG
03	LEDC L.P. #17 LED 1968 MUSTANG	LEDC L.P. #18 LED 2000 MUSTANG	LEDC L.P. #19 LED 2ND GEAR	LEDC L.P. #20 LED 4TH GEAR	LEDC L.P. #21 LED 1ST GEAR	LEDC L.P. #22 LED 3RD GEAR	LEDC L.P. #23 LED 5TH GEAR	LEDC L.P. #24 LED TECH UPGRADE
04	LEDC L.P. #25 LED HANDLING UPGRADE	LEDC L.P. #26 LED 4TH GEAR (GREEN)	LEDC L.P. #27 LED TIRES UPGRADE	LEDC L.P. #28 LED ENGINE UPGRADE	LEDC L.P. #29 LED DRIVE TRAIN UPGRADE	LEDC L.P. #30 LED BODY MODS	LEDC L.P. #31 LED N20 UPGRADE	LEDC L.P. #32 LED SHOT ARROW #1
05	LEDC L.P. #33 LED SHOT ARROW #2	LEDC L.P. #34 LED 6TH GEAR (RED)	LEDC L.P. #35 LED JACKPOT (LEFT)	LEDC L.P. #36 LED N20 (LEFT)	LEDC L.P. #37 LED EXTRA BALL	LEDC L.P. #38 LED START N20	LEDC L.P. #39 LED LEFT ORBIT (GREEN)	LEDC L.P. #40 LED LEFT ORBIT (YELLOW)
06	LEDC L.P. #41 LED LEFT ORBIT (RED)	LEDC L.P. #42 LED 6TH GEAR (GREEN)	LEDC L.P. #43 LED JACKPOT (RIGHT)	LEDC L.P. #44 LED N20 (RIGHT)	LEDC L.P. #45 LED SHOT ARROW #5	LEDC L.P. #46 LED JACKPOT (CENTER)	LEDC L.P. #47 LED RIGHT ORBIT (GREEN)	LEDC L.P. #48 LED RIGHT ORBIT (YELLOW)
07	LEDC L.P. #49 LED RIGHT 3 BANK (BOTTOM)	LEDC L.P. #50 LED MULTIBALL	LEDC L.P. #51 LED SHOT ARROW #8 (R)	LEDC L.P. #52 LED SHOT ARROW #7	LEDC L.P. #53 LED JACKPOT (RIGHT)	LEDC L.P. #54 LED N20 (RIGHT)	LEDC L.P. #55 LED RIGHT ORBIT (GREEN)	LEDC L.P. #56 LED RIGHT ORBIT (YELLOW)
08	LEDC L.P. #57 LED RIGHT ORBIT (RED)	LEDC L.P. #58 LED SHOT ARROW #3	LEDC L.P. #59 LED SHOT ARROW #6	LEDC L.P. #60 LED SHOT ARROW #4	LEDC L.P. #61 LED N20 (CENTER)	LEDC L.P. #62 LED PONY TOP LANE #1 (L)	LEDC L.P. #63 LED PONY TOP LANE #2	LEDC L.P. #64 LED PONY TOP LANE #3
09	LEDC L.P. #65 LED PONY TOP LANE #4	LEDC L.P. #66 LED (M)MUSTANG	LEDC L.P. #67 LED M(U)STANG	LEDC L.P. #68 LED MU(S)TANG	LEDC L.P. #69 LED MUST(A)NG	LEDC L.P. #70 LED MUST(A)NG	LEDC L.P. #71 LED MUSTA(N)G	LEDC L.P. #72 LED MUSTAN(G)
10	LEDC L.P. #73 LED FORD TOP LANE #1 (L)	LEDC L.P. #74 LED FORD TOP LANE #2	LEDC L.P. #75 LED FORD TOP LANE #3	LEDC L.P. #76 LED FORD TOP LANE #4	LEDC L.P. #77 LED TOP POP BUMPER	LEDC L.P. #78 LED LEFT POP BUMPER	LEDC L.P. #79 LED BOTTOM POP BUMPER	LEDC L.P. #80 LED RIGHT POP BUMPER

FOR MORE ABOUT OUR CENTER, VISIT US AT WWW.CHEVROLET.COM
 MAIL STRIPS TO: CHEVROLET, 300 N. ZEEB RD., WYOMING, WY 83001
 SEC. 2, CAP. 2, INGBR 104-105

When Color Abbreviations used: BLK Black, RED Red, GRN Green, BLU Blue, VIO Violet, GRY Grey, YEL Yellow

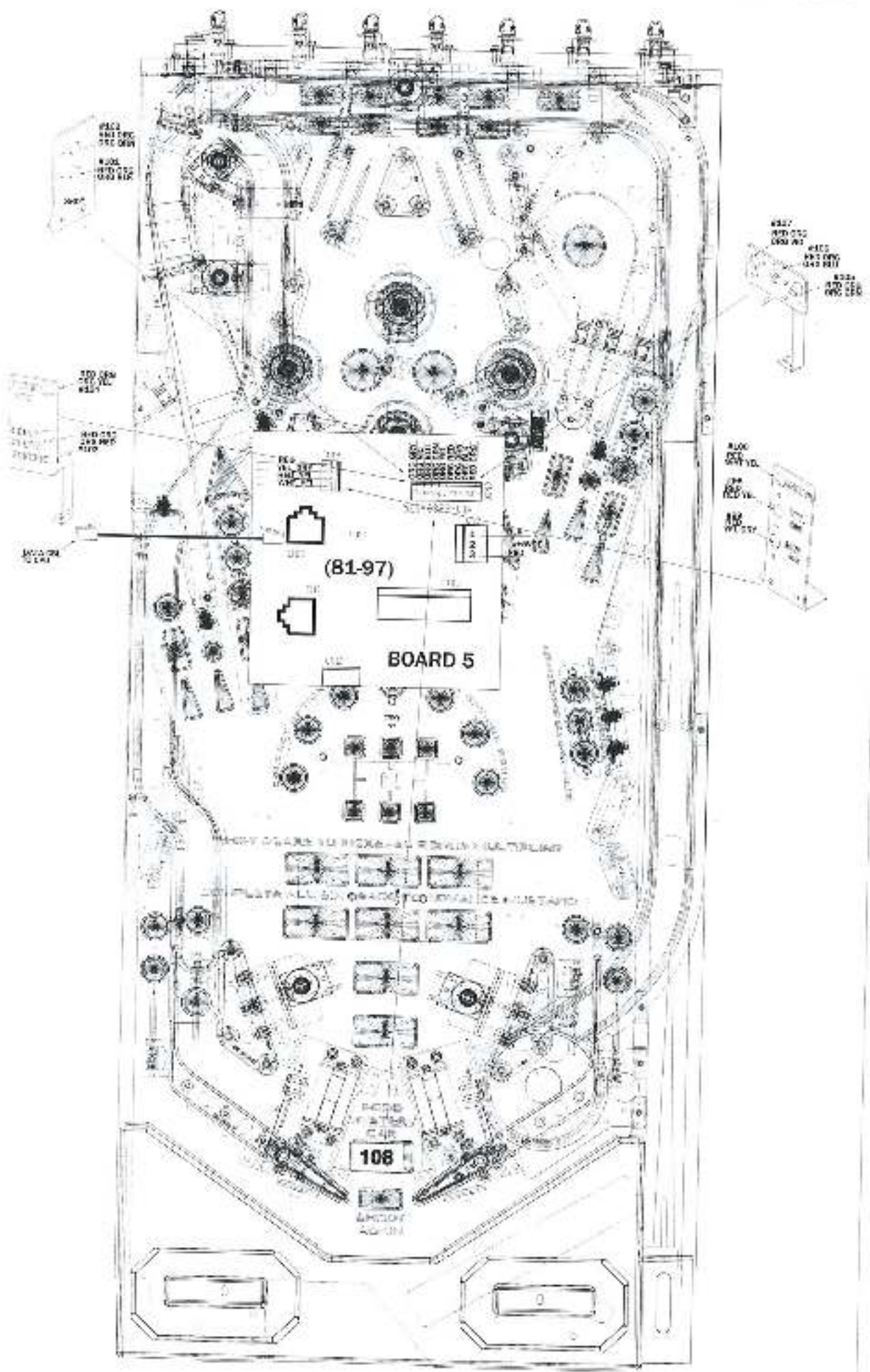



Game-Specific Tests

To initiate, from the **DIAGNOSTICS MENU**, select the "GAME" icon. Ensure the Power Interlock Switch is pulled out when testing with the Coin Door open. This Menu is provided to allow the technician a simple method of testing game specific coils and/or switches, if required. If used, select the icon (and Sub-Menu icons, if any) and follow on-screen prompts.



Ball Trough Test

To initiate, from the **DIAGNOSTICS MENU**, select the "CLR" icon. Ensure the **Power Interlock Switch** is pulled out if testing with the Coin Door open. This Menu is provided to allow the technician a simple method of removing the balls from the trough and also, to test functionality of the trough, ensuring proper trough operation. Upon entering **Ball Trough Test**, you will notice that four switches are already indicated as closed. In the example, the 4-Ball Trough Switches #18, #19, #20 & #21 are shown closed (pinballs at rest in the ball trough). To return to the **DIAGNOSTICS MENU**, press the **Green [BACK] Button**.



Press the **Black [SELECT] Button** to eject the ball in the first position Switch #21 (VUK OPTO Trough #1 (R)). Simultaneously, the Dot Matrix Display and the playfield will eject the ball to the Trough Up-Kicker, eject from the Trough Up-Kicker into the Shooter Lane, momentarily closing Switch #23 (Shooter Lane), and is ejected onto the playfield where the technician can easily retrieve the pinball or allow the ball(s) to re-enter the trough to continue **Ball Trough Test**. The Dot Matrix Display indicates Switch #18 (4-Ball Trough #4 (L)) as open as the remaining three (3) pinballs shift over one (1) position to the right. If the technician allows the ejected pinball to reenter the ball trough, the Dot Matrix Display will indicate Switch #18 as closed. **REMINDER: Switch #22 is the stacking OPTO switch; if more than five (5) pinballs are used, the additional switches will be noted. Typically, four (4) pinballs are used and required for proper operation; if this amounts differs, it will be noted on the front page of this Service Game Manual.**



CAUTION! Continuous use off the above test may overheat the Trough Up-Kicker Coil.



Technician Alerts

To initiate, from the **DIAGNOSTICS MENU**, select the "TECH" icon. This Menu is provided to show any switch or solenoid problems and/or missing pinballs. If upon entering the **SERVICE MENU** the display indicated an asterisk (*) and "USE -/+ TO VIEW TECH. ALERTS", alerts are present.

TECHNICIAN ALERT - (0/0)

NO TECHNICIAN ALERTS

PRESS 'BACK' TO EXIT



After pressing either Red [</-] / [+/>] Button or selecting this icon in the **DIAGNOSTICS MENU**, the display will indicate the alert(s). If there are 2 alerts present, the display will indicate (1/2) with the 1st alert on the display. Press the Red [+/>] Button to view the second alert (2/2). The second number in the parenthesis () after the slash (/) indicates how many alerts are present. Refer to the start of this chapter regarding "Upon entering the **SERVICE MENU** * indication and to **SWITCH ALERTS**. To return to the **DIAGNOSTICS MENU**, press the **Green [BACK] Button**. **Note: While in this menu, an option may be present to jump (short-cut) to the appropriate Testing Menu (e.g. Coil Test, Switch Test, Game Specific Test or Ticket Dispenser Test, if installed).**

NOTE ON SWITCH DETECTION: During game play, activation of switches are continuously monitored. For a switch to be determined as inoperable or **OUT OF SERVICE**, up to twenty games or so must be played for a switch to be automatically marked as **OUT OF SERVICE**. In programming, if a switch is determined to be faulty, game play is compensated. Switches noted as **OUT OF SERVICE** are determined to be stuck closed or open depending on switch usage. Free up the switch actuator, adjust or replace, if necessary. Performing a valid switch closure will put the switch back "IN SERVICE."

Determination of switch usage can be checked in **Audits** (review the Audits Section). Find the associated Audit with the switch in question and check usage; compare the numbers to commonly used switches. After any switch is checked and repaired or replaced, it's suggested to test the switch in the **Switch Test** or **Single Coil Test** (reviewed earlier in this section) where the associated coil to the switch can be tested as well. After correcting the problem, the switch will marked "IN SERVICE" and the switch is again monitored as specified above. Only you can determine if a switch marked **OUT OF SERVICE** is actually inoperable, or if it is just not getting actuated during game play.

NOTE ON PINBALL DETECTION: While in **TECHNICIAN ALERTS MENU**, if the following is displayed, the game has detected one (1) or more pinball(s) missing and has compensated for the lost pinball(s) to provide normal game play.

Technician Alerts continued on the next page.



Technician Alerts continued from previous page.

During game play, a pinball can get trapped or stuck. If after approximately 15 seconds of inactivity or "no scoring," **Ball Search** is started. **Note:** If the pinball is in the Plunger Lane or "held" on the flipper, no **Ball Search** will be performed. The game will perform one **Ball Search** in an attempt to "find" or free-up the pinball.

If the game does not see a switch closure (indicating the pinball has not been found), the Dot Matrix Display may indicate [**LOCATING PINBALLS PLEASE WAIT ...**], during which **Ball Search** will continue until the timer runs out (this feature will not happen if the game is in Competition Mode; **Ball Search** will continue until the pinball is found, unstuck and/or replaced manually). The display will momentarily acknowledge the missing pinball(s). The game will provide another pinball into play and will compensate for the lost pinball. Game play will appear normal.

Note: This detection and compensation will happen with every pinball, if each suffers the same fate of a ball trap. If all balls get trapped, the game cannot be played or started until the situation is rectified.

Important: Determine where the pinball is! **Do not add pinball(s)** until it is determined the pinball(s) are indeed missing and not just stuck. The most common places for a pinball to be stuck is in device holes (ejects and VUKs) or ball troughs. Determine that all devices are functionally properly. Check around plastic pieces and ramps to see if the pinball got jammed or stuck.

When the found pinball or a replacement pinball is added to the Ball Trough, the Technician Alert will immediately clear and will then indicate any remaining alerts (if present) or **NO TECHNICIAN ALERTS**.

Enter the **BALL TROUGH TEST** (review the previous page) to cycle the pinballs and to check proper switch and coil operation. If a pinball was added, and the originally stuck pinball has freed itself at a later time, the game will not operate correctly.

NOTE ON DEVICE MALFUNCTION: While in **TECHNICIAN ALERTS MENU**, if the following is displayed, the game has detected a "device malfunction." Check the device indicated (coil and/or switch).

TECHNICIAN ALERT - (1/2)
2
BALLS MISSING
PRESS 'SELECT' FOR TROUGH TEST

TECHNICIAN ALERT - (2/2)
DEVICE MALFUNCTION
AUTO PLUNGER
USE -/+ TO VIEW OTHER ALERTS



Knocker Test

To initiate, from the **DIAGNOSTICS MENU**, select the "KNOCKER" icon. The digitally mastered "Knocker" is sounded. The *knocker sound* is used to alert the player if he/she has received a special, replay or a credit from the Match Award feature. Press the **Black [SELECT] Button** to activate the knocker. To return to the **DIAGNOSTICS MENU**, press the **Green [BACK] Button**.

FACTOID: The knocker got it's name from the 'original knocker' (20th century pinball games), which used a coil and when energized (fired), the plunger would strike a wood panel inside the cabinet.



Sound / Speaker Test

To initiate, from the **DIAGNOSTICS MENU**, select the "SPKR" icon. This system produces true digital stereo sound from Backbox & Cabinet Speakers or "Mono" on the Cabinet Speaker (when used by itself). This Menu is provided to allow the technician a simple method of testing the speakers if rewired or replaced.

Upon entering **Sound / Speaker Test**, you will notice the Dot Matrix Display indicating the first option of available music and/or sound(s) in this test. Press the **Red [+ / >] Button** to cycle through the available music and/or sounds, and press the **Black [SELECT] Button** to play the option shown in the Dot Matrix Display. Press the **Green [BACK] Button** to exit.

Speaker Phase Testing

Connections to each of speakers are polarized and each must be connected appropriately for the best quality sound. If one speaker has the positive and negative connections reversed with respect to the other one, bass frequencies will not be produced properly and the overall sound quality will be poor. To test for proper speaker phasing, use the **Sound / Speaker Test** to cycle through the available music and sound.

SOUND / SPEAKER TEST
MUSIC: MAIN PLAY
#1
PRESS 'SELECT' TO PLAY

SOUND / SPEAKER TEST
MUSIC: MAIN PLAY
#1
PLAYING SOUND #1

Speaker Phase Testing cont. next page.



Speaker Phase Testing continued from previous page.

If the sound is not balanced or doesn't sound correct, check the speaker wiring.

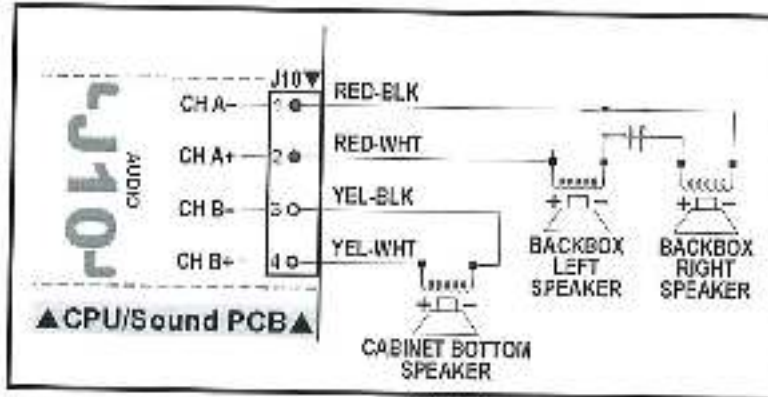

1. Check each speaker for polarity markings. If the speakers have polarity markings, verify that the Backbox Speaker's **RED-BLK** Wires and the Cabinet Speaker **YEL-BLK** Wire(s) are connected to the negative (-) terminal.

2. Disconnect the speaker output Connector **J10 (AUDIO)** from the CPU / Sound PCB (in the Backbox) and connect a 1.5-volt battery across each speaker pair one at a time while observing the speakers.

3. Make sure the positive (+) battery terminal is connected to the positive lead [J10, Pin-2, CH A+] (**RED-WHT**) or [J10, Pin-4, CH B+]

(**YEL-WHT**) each time. As the connection is made, check speaker cone movement; proper connections are indicated by outward movement.



Begin Burn-In

To initiate, from the **DIAGNOSTICS MENU**, select the "BURN" icon. After selecting this icon, press the **Black [SELECT] Button** to begin (initiate) the **Burn-In Test**. Ensure the **Power Interlock Switch** is pulled out if testing with the Coin Door open (required for coil function). Upon entering **Burn-In Test**, the game will exercise all CPU I/O Functions: **Dot Matrix Display Test, Coil Cycling Testing, All Lamps Test** and **Sound / Speaker Test**. Press the **Green [BACK] Button**, to pause and to view the cumulative Burn-In minutes. Press the **Green [BACK] Button** again to return to the **DIAGNOSTICS MENU**.

Note: To reset Burn-In minutes back to 0:00, see Section 3, Chapter 5, **GO TO RESET MENU** (via the **UTILITIES MENU**), **Reset Factory Settings**. **CAUTION:** Performing a **FACTORY RESET** will reset all other information as well (read the Utilities Section (**GO TO RESET MENU**), for more information).



Dot Matrix Test

To initiate, from the **DIAGNOSTICS MENU**, select the "DOT TEST" icon. After selecting this icon the **Dot Matrix Test** immediately begins. The Dot Matrix Display will immediately and continuously illuminate and cycle each of the 5 Tests for 1 pass each. To return to the **DIAGNOSTICS MENU**, press the **Green [BACK] Button**.

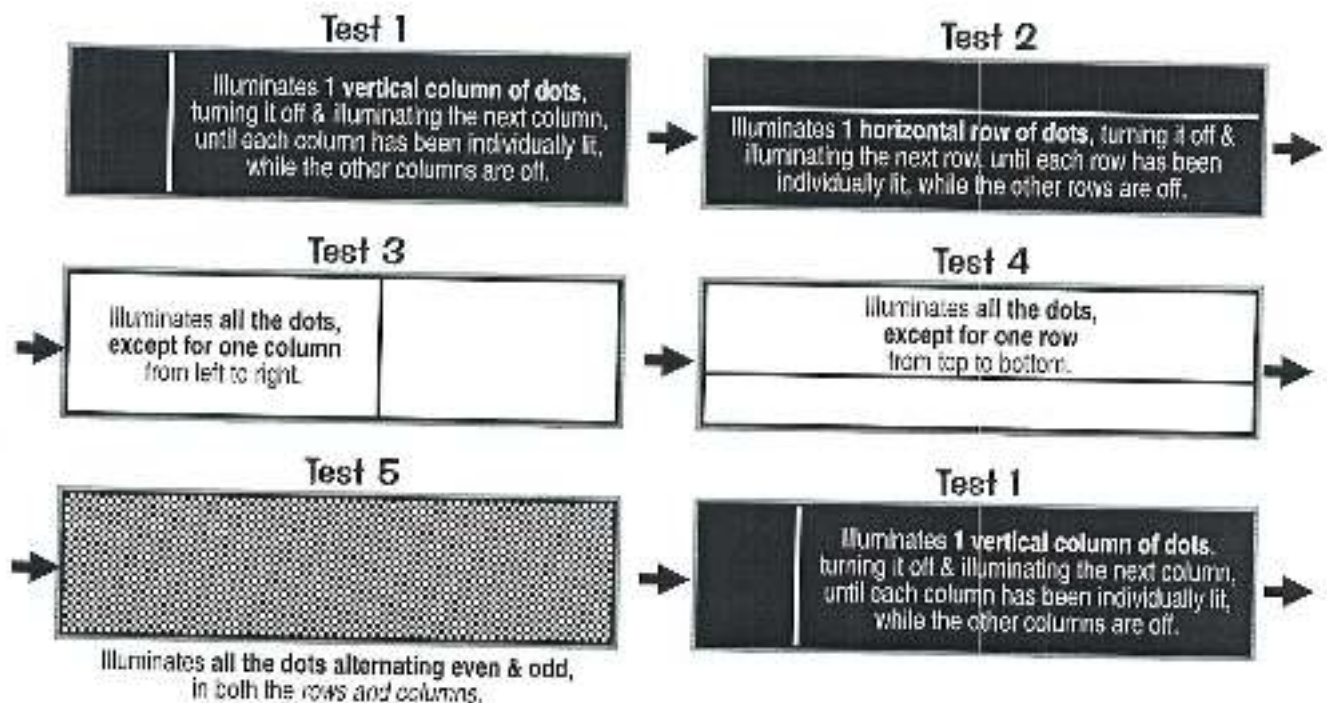



Ticket Dispenser Test

To initiate, from the **DIAGNOSTICS MENU**, select the "TIX" icon. This Menu (icon) *will only appear* if Standard Adjustment 56, **Ticket Dispenser**, is set to **YES** (Default = **NO***). **Note:** Some games shipped from the factory with a unique Dip Switch Setting will default to **YES**. To view and/or change your setting, see Adjustments Section (**GO TO ADJUSTMENTS MENU**). Please remember, if you install an optional Ticket Dispenser, and your default setting is "NO," you will have to reset it back to "YES" if a **Factory Reset** is performed.

After selecting this icon, the **Ticket Dispenser Test** will start. With the Ticket Dispenser properly installed, manually feed your tickets into the dispenser. The dispenser will activate and pull in the first ticket. Press the **Black [SELECT] Button** (which energizes Coil #35, Aux 3: Switched Ground) to advance a ticket. Feeding your Tickets into the dispenser works because Coil #33, Aux 1: Ticket Advance (Enable) is always 'energized'. With a Ticket Meter installed, as one Ticket Passes through the Ticket Dispenser, one 'click' is fired to the Meter (Coil #34, Aux 2: Ticket Meter) for each ticket passing through. Dedicated Switch **D-19, Ticket Notch**, will also be indicated on-screen (*in combination with a audible sound*) as 'closing' as the notch between the tickets passes through. In this test you can clear ticket jams and check and/or clear tickets in Escrow, if necessary. To return to the **DIAGNOSTICS MENU**, press the **Green [BACK] Button**.



GO TO AUDITS MENU: EARNINGS AUDITS [#1 - #13] / STANDARD AUDITS [#1 - #59]

Perform the below steps to review the audits. Enter the **SERVICE MENU**, then enter the **EARNINGS AUDITS** or **STANDARD AUDITS MENUS**. For audit definitions or summary, review the Audits Section (**GO TO AUDITS MENU**). Try the **"DUMP AUDITS TO USB"** Feature to create a text file of your audits. Don't forget to set the **DATE & TIME** in the **UTILITIES MENU**. See the Utilities Section (**GO TO UTILITIES MENU**).

Step 1 Press [**SELECT**].
Press [**BACK**] to exit for escape at any time.

Step 2 Press [**>**]. Go to the 'AUD' icon.
Press [**SELECT**].

Step 3 Press [**>**]. Go to the 'EARN' or 'S.P.I.' icon.
Press [**SELECT**].

Step 4 Press [**<**] [**>**] to move between audits.

Audit Number →
Audit Name →
Audit Result →

EARNINGS AUDIT #1
TOTAL PAID CREDITS
0

EARNINGS AUDITS [#1 - #13] ▼

Nr.	EARNINGS AUDIT NAME	YOUR RESULT	Nr.	EARNINGS AUDIT NAME	YOUR RESULT
1	TOTAL PAID CREDITS		8	COINS THROUGH FOURTH SLOT	
2	FREE GAME PERCENTAGE		9	COINS THROUGH FIFTH SLOT	
3	AVERAGE BALL TIME		10	TOTAL COINS	
4	AVERAGE GAME TIME		11	TOTAL EARNINGS	
5	COINS THROUGH LEFT SLOT		12	METER CLICKS	
6	COINS THROUGH RIGHT SLOT		13	SOFTWARE METER	
7	COINS THROUGH CENTER SLOT				

STANDARD AUDITS [#1 - #59] ▼

Nr.	STANDARD AUDIT NAME	YOUR RESULT	Nr.	STANDARD AUDIT NAME	YOUR RESULT	Nr.	STANDARD AUDIT NAME	YOUR RESULT
1	TOTAL BALLS PLAYED		21	3.0M - 3.99M SCORES		41	RIGHT DRAINS	
2	TOTAL EXTRA BALLS		22	10.0M - 12.49M SCORES		42	TILTS	
3	EXTRA BALL PERCENTAGE		23	12.5M - 14.99M SCORES		43	TOTAL BALLS SAVED	
4	REPLAY 1 AWARDS		24	15.0M - 17.49M SCORES		44	LEFT FLIPPER USED	
5	REPLAY 2 AWARDS		25	17.5M - 19.99M SCORES		45	RIGHT FLIPPER USED	
6	REPLAY 3 AWARDS		26	20.0M - 24.99M SCORES		46	0 - 1 MINUTE GAMES	
7	REPLAY 4 AWARDS		27	25.0M - 29.99M SCORES		47	1 - 1.5 MINUTE GAMES	
8	TOTAL REPLAYS		28	30.0M - 39.99M SCORES		48	1.5 - 2 MINUTE GAMES	
9	REPLAY PERCENTAGE		29	40.0M - 49.99M SCORES		49	2 - 2.5 MINUTE GAMES	
10	TOTAL SPECIALS		30	50.0M - 74.99M SCORES		50	2.5 - 3 MINUTE GAMES	
11	SPECIAL PERCENTAGE		31	75.0M - 99.99M SCORES		51	3 - 3.5 MINUTE GAMES	
12	TOTAL MATCHES		32	100.0M - 149.99M SCORES		52	3.5 - 4 MINUTE GAMES	
13	HIGH SCORE AWARDS		33	150.0M+ SCORES		53	4 - 5 MINUTE GAMES	
14	HIGH SCORE PERCENT		34	AVERAGE SCORES		54	5 - 6 MINUTE GAMES	
15	TOTAL FREE PLAYS		35	SERVICE CREDITS		55	6 - 8 MINUTE GAMES	
16	TOTAL PLAYS		36	BALL SEARCH STARTED		56	8 - 10 MINUTE GAMES	
17	0.0M - 1.99M SCORES		37	LOST BALL FEEDS		57	10 - 15 MINUTE GAMES	
18	2.0M - 3.99M SCORES		38	LOST BALL GAME STARTS		58	15+ MINUTE GAMES	
19	4.0M - 5.99M SCORES		39	LEFT DRAINS		59	RECENT REPLAY PERCENT	
20	6.0M - 7.99M SCORES		40	CENTER DRAINS				

Note: audits are subject to change (with or without notice).

STANDARD ADJUSTMENTS [#1 - #63] ▼

Nr.	STANDARD ADJUSTMENT NAME	USA DEFAULT	YOUR SETTING	Nr.	STANDARD ADJUSTMENT NAME	USA DEFAULT	YOUR SETTING
1	REPLAY TYPE	AUTO		32	HIGH SCORE #1	_,000,000	
2	REPLAY PERCENTAGE	10%		33	HIGH SCORE #2	_,000,000	
3	REPLAY AWARD	CREDIT		34	HIGH SCORE #3	_,000,000	
4	REPLAY LEVELS	1		35	HIGH SCORE #4	_,000,000	
5	AUTO REPLAY START	_,000,000		36	HSTD INITIALS	3 INITIALS	
6	DYNAMIC REPLAY START	_,000,000		37	HSTD RESET COUNT	2000	
7	REPLAY LEVEL #1	_,000,000		38	FREE PLAY	NO	
8	REPLAY LEVEL #2	_,000,000		39	LANGUAGE	ENGLISH	
9	REPLAY LEVEL #3	_,000,000		40	PLAYER LANGUAGE SELECT	YES	
10	REPLAY LEVEL #4	_,000,000		41	CUSTOM MESSAGE	ON	
11	REPLAY BOOST	YES		42	FLASH LAMP POWER	NORMAL	
12	SPECIAL LIMIT	1		43	COIL PULSE POWER	NORMAL	
13	SPECIAL PERCENTAGE	10%		44	KNOCKER VOLUME	NORMAL	
14	SPECIAL AWARD	CREDIT		45	GAME RESTART	YES	
15	FREE GAME LIMIT	5		46	BILL VALIDATOR	NO	
16	EXTRA BALL LIMIT	5		47	MUSIC VOLUME	1	
17	EXTRA BALL PERCENTAGE	25%		48	BALL SAVE TIME	0:05	
18	GAME PRICING	USA 10		49	TIMED PLUNGER	OFF	
19	MATCH PERCENTAGE	9%		50	FLIPPER BALL LAUNCH	OFF	
20	MATCH AWARD	CREDIT		51	COINDOOR BALL SAVER	NO	
21	BALLS PER GAME	3		52	COMPETITION MODE	NO	
22	TILT WARNINGS	2		53	CONSOLATION BALL	YES	
23	CREDIT LIMIT	30		54	FAST BOOT	YES	
24	ALLOW HIGH SCORES	YES		55	Q24 OPTION	COIN METER	
25	HIGH SCORE AWARD	CREDIT		56	TICKET DISPENSER	NO	
26	GRAND CHAMPION AWARDS	1		57	PLAYER COMPETITION	YES	
27	HIGH SCORE #1 AWARDS	1		58	TEAM SCORES	NO	
28	HIGH SCORE #2 AWARDS	0		59	LOCATION ID	0	
29	HIGH SCORE #3 AWARDS	0		60	GAME ID	0	
30	HIGH SCORE #4 AWARDS	0		61	TIME FORMAT	12-HOUR	
31	GRAND CHAMPION SCORE	_,000,000		62	COIN INPUT DELAY	30	
				63	LOST BALL RECOVERY	YES	

Factory Defaults Settings are subject to change during production (especially Standard Adjustments 2, 4, 5, 13, 16-17, 19, 31-35 & 47).
 † Not all Standard Adjustments are shown. Depending on the setting (whether Factory Default or if changed by the operator), associated adjustments do not appear, if not required. **NOTE:** If Game Dip Switch other than USA is installed, different Defaults will appear.



Feature Adjustments [#1 - #+]

GAME

To initiate, from the **ADJUSTMENTS MENU**, select the "GAME" icon. The Dot Matrix Display will indicate the adjustment number (in this group), adjust. name, adjust. setting and comment line. The current adjustment will remain on the display until the next adjustment is viewed or when this sub-menu is exited.

>>> **FACTORY RESET or CODE UPDATE NOTE:** Don't forget, any changes you make to your adjustments will revert back to the Factory Default settings if you perform a Factory Reset or update your Game Code. See Utilities Section (**GO TO RESETS MENU** and **GO TO USB MENU**).

View the Coils Detailed Chart Menu to see if this game is Shaker Motor Enabled. If it is, set the options in the Feature Adjustment as seen below. (typically the last one).

SHAKER MOTOR (OPTIONAL): Set to **NONE, MINIMAL USE, MODERATE USE** or **MAXIMAL USE**.
 Factory Default = **MODERATE USE**. Set to any of the varying "... USES" if an Optional Shaker Motor Kit (SPI Part Number 502-5027-00) was installed correctly in this pinball machine. See the assembly (kit) on the last page of Blue Pages (Major Assemblies). Also see Shaker Motor Coil (Q5) in the Coils Detailed Chart Table at the beginning of this Service Game Manual or the beginning of the Yellow Pages.

CPU/SOUND PCB DIP SWITCH SW1 SETTING		COUNTRY SETTING OPTION(S)	COIN MECHANISMS (SWITCHES) COINS THRU... SLOT:				PRICING SCHEME Number of Plays (Credits) for Price Amount Shown See "Appendix J" for Coin Cards Examples & Info!			Requires SR Coin Card(s) Part Number													
Pos.	1	2	3	4	5	6	7	8	LEFT	CENTER	RIGHT	4TH											
Pos.	1	2	3	4	5	6	7	8					USD / UNITED STATES DOLLAR (US \$)										
ON	▲	▲	▲	▲	▲	▲	▲	▲					1/0.25				755-5400-01-Y						
OFF	▼	▼	▼	▼	▼	▼	▼	▼					1/0.50	2/0.75	3/1.00		755-5400-02-Y						
HIGHLIGHTED = Factory Default		USA 1		USA 2		USA 3		USA 4		USA 5		USA 6		USA 7		USA 8		USA 9		USA 10		USA 11	
HIGHLIGHTED = Not Shown on Coin Card		USA 1		USA 2		USA 3		USA 4		USA 5		USA 6		USA 7		USA 8		USA 9		USA 10		USA 11	
Pos.	1	2	3	4	5	6	7	8					AUD / AUSTRALIAN DOLLARS (A\$)										
ON	▲	▲	▲	▲	▲	▲	▲	▲					1/1.00				755-5400-01-Y						
OFF	▼	▼	▼	▼	▼	▼	▼	▼	0.20	1.00	2.00			1/1.00	3/2.00								
HIGHLIGHTED = Not Shown on Coin Card		AUSTRALIA 1		AUSTRALIA 2		AUSTRALIA 3		AUSTRALIA 4		AUSTRALIA 5		AUSTRALIA 6		AUSTRALIA 7		AUSTRALIA 8		AUSTRALIA 9		AUSTRALIA 10		AUSTRALIA 11	
Pos.	1	2	3	4	5	6	7	8					CAD / CANADIAN DOLLARS (C\$)										
ON	▲	▲	▲	▲	▲	▲	▲	▲					1/0.50	2/0.75	3/1.00		755-5400-00-Y						
OFF	▼	▼	▼	▼	▼	▼	▼	▼	1.00		2.00			1/1.00	3/2.00								
HIGHLIGHTED = Not Shown on Coin Card		CANADA 1 (25c door)		CANADA 2 (dollar door)		CANADA 3		CANADA 4		CANADA 5		CANADA 6		CANADA 7		CANADA 8		CANADA 9		CANADA 10		CANADA 11	
Pos.	1	2	3	4	5	6	7	8					HRK / CROATIAN KUNA (Kuna)										
ON	▲	▲	▲	▲	▲	▲	▲	▲					1	2	5		755-5410-01-Y						
OFF	▼	▼	▼	▼	▼	▼	▼	▼	1		5			1/3	2/5								
HIGHLIGHTED = Not Shown on Coin Card		CROATIA		CROATIA 2		CROATIA 3		CROATIA 4		CROATIA 5		CROATIA 6		CROATIA 7		CROATIA 8		CROATIA 9		CROATIA 10		CROATIA 11	
Pos.	1	2	3	4	5	6	7	8					DKK / DANISH KRONE (DKr)										
ON	▲	▲	▲	▲	▲	▲	▲	▲					1	5	10	20		755-5410-00-Y					
OFF	▼	▼	▼	▼	▼	▼	▼	▼	1		5	10	20	1/2	2/4	3/5	4/7	5/9	7/10				
HIGHLIGHTED = Not Shown on Coin Card		DENMARK 1		DENMARK 2		DENMARK 3		DENMARK 4		DENMARK 5		DENMARK 6		DENMARK 7		DENMARK 8		DENMARK 9		DENMARK 10		DENMARK 11	
Pos.	1	2	3	4	5	6	7	8					JPY / JAPANESE YEN (¥)										
ON	▲	▲	▲	▲	▲	▲	▲	▲					100		100		755-5401-01-Y						
OFF	▼	▼	▼	▼	▼	▼	▼	▼	100		100			1/100	3/200								
HIGHLIGHTED = Not Shown on Coin Card		JAPAN 1		JAPAN 2		JAPAN 3		JAPAN 4		JAPAN 5		JAPAN 6		JAPAN 7		JAPAN 8		JAPAN 9		JAPAN 10		JAPAN 11	
Pos.	1	2	3	4	5	6	7	8					LTL / LITHUANIAN LITAS (Lt)										
ON	▲	▲	▲	▲	▲	▲	▲	▲					1	2	5		755-5416-01-Y						
OFF	▼	▼	▼	▼	▼	▼	▼	▼	1		2	5		1/2									
HIGHLIGHTED = Not Shown on Coin Card		LITHUANIA		LITHUANIA 2		LITHUANIA 3		LITHUANIA 4		LITHUANIA 5		LITHUANIA 6		LITHUANIA 7		LITHUANIA 8		LITHUANIA 9		LITHUANIA 10		LITHUANIA 11	
Pos.	1	2	3	4	5	6	7	8					MIDEAST / MIDDLE EAST (East currency used to buy token)										
ON	▲	▲	▲	▲	▲	▲	▲	▲					token		token		755-5410-00-Y						
OFF	▼	▼	▼	▼	▼	▼	▼	▼	token		token			1/1									
HIGHLIGHTED = Not Shown on Coin Card		MIDDLE EAST		MIDDLE EAST 2		MIDDLE EAST 3		MIDDLE EAST 4		MIDDLE EAST 5		MIDDLE EAST 6		MIDDLE EAST 7		MIDDLE EAST 8		MIDDLE EAST 9		MIDDLE EAST 10		MIDDLE EAST 11	
Pos.	1	2	3	4	5	6	7	8					NZD / NEW ZEALAND DOLLARS (NZD)										
ON	▲	▲	▲	▲	▲	▲	▲	▲					1		2		755-5405-01-Y						
OFF	▼	▼	▼	▼	▼	▼	▼	▼	1		2			1/1	3/2								
HIGHLIGHTED = Not Shown on Coin Card		NEW ZEALAND 1		NEW ZEALAND 2		NEW ZEALAND 3		NEW ZEALAND 4		NEW ZEALAND 5		NEW ZEALAND 6		NEW ZEALAND 7		NEW ZEALAND 8		NEW ZEALAND 9		NEW ZEALAND 10		NEW ZEALAND 11	
Pos.	1	2	3	4	5	6	7	8					NOK / NORWEGIAN KRONE (Nkr)										
ON	▲	▲	▲	▲	▲	▲	▲	▲					10	5	20		755-5400-01-Y or						
OFF	▼	▼	▼	▼	▼	▼	▼	▼	10	5	20			1/10	3/20								
HIGHLIGHTED = Not Shown on Coin Card		NORWAY 1		NORWAY 2		NORWAY 3		NORWAY 4		NORWAY 5		NORWAY 6		NORWAY 7		NORWAY 8		NORWAY 9		NORWAY 10		NORWAY 11	
Pos.	1	2	3	4	5	6	7	8					RUB / RUSSIAN RUBLE (R Ruble)										
ON	▲	▲	▲	▲	▲	▲	▲	▲					10	5	1		755-5411-00-Y						
OFF	▼	▼	▼	▼	▼	▼	▼	▼	10	5	1			1/5									
HIGHLIGHTED = Not Shown on Coin Card		RUSSIA		RUSSIA 2		RUSSIA 3		RUSSIA 4		RUSSIA 5		RUSSIA 6		RUSSIA 7		RUSSIA 8		RUSSIA 9		RUSSIA 10		RUSSIA 11	
Pos.	1	2	3	4	5	6	7	8					ZAR / SOUTH AFRICAN RAND (R R)										
ON	▲	▲	▲	▲	▲	▲	▲	▲					0.50	1.00	2.00	5.00		755-5405-01-Y					
OFF	▼	▼	▼	▼	▼	▼	▼	▼	0.50	1.00	2.00	5.00		1/2.00	2/5.00								
HIGHLIGHTED = Not Shown on Coin Card		SO. AFRICA 1		SO. AFRICA 2		SO. AFRICA 3		SO. AFRICA 4		SO. AFRICA 5		SO. AFRICA 6		SO. AFRICA 7		SO. AFRICA 8		SO. AFRICA 9		SO. AFRICA 10		SO. AFRICA 11	
Pos.	1	2	3	4	5	6	7	8					SEK / SWEDISH KRONE (Skr)										
ON	▲	▲	▲	▲	▲	▲	▲	▲					1	5	10		755-5400-00-Y						
OFF	▼	▼	▼	▼	▼	▼	▼	▼	1	5	10			1/10	2/15	3/20							
HIGHLIGHTED = Not Shown on Coin Card		SWEDEN 1		SWEDEN 2		SWEDEN 3		SWEDEN 4		SWEDEN 5		SWEDEN 6		SWEDEN 7		SWEDEN 8		SWEDEN 9		SWEDEN 10		SWEDEN 11	
Pos.	1	2	3	4	5	6	7	8					CHF / SWISS FRANC (Sfr)										
ON	▲	▲	▲	▲	▲	▲	▲	▲					1	2	5		755-5415-00-Y						
OFF	▼	▼	▼	▼	▼	▼	▼	▼	1	2	5			1/1	2/2	3/3	4/4	5/5					
HIGHLIGHTED = Not Shown on Coin Card		SWITZERLAND 1		SWITZERLAND 2		SWITZERLAND 3		SWITZERLAND 4		SWITZERLAND 5		SWITZERLAND 6		SWITZERLAND 7		SWITZERLAND 8		SWITZERLAND 9		SWITZERLAND 10		SWITZERLAND 11	
Pos.	1	2	3	4	5	6	7	8					TWD / TAIWANESE DOLLAR (T\$)										
ON	▲	▲	▲	▲	▲	▲	▲	▲					10		10		755-5412-01-Y						
OFF	▼	▼	▼	▼	▼	▼	▼	▼	10		10			1/10									
HIGHLIGHTED = Not Shown on Coin Card		TAIWAN		TAIWAN 2		TAIWAN 3		TAIWAN 4		TAIWAN 5		TAIWAN 6		TAIWAN 7		TAIWAN 8		TAIWAN 9		TAIWAN 10		TAIWAN 11	
Pos.	1	2	3	4	5	6	7	8					GBP / UNITED KINGDOM POUNDS (P £)										
ON	▲	▲	▲	▲	▲	▲	▲	▲					LEFT	CENTER	RIGHT	4TH	5TH		755-5407-00-Y				
OFF	▼	▼	▼	▼	▼	▼	▼	▼	0.10	0.50	1.00	0.20	2£	3/1.00	7/2.00								
HIGHLIGHTED = Not Shown on Coin Card		UK 1		UK 2		UK 3		UK 4		UK 5		UK 6		UK 7		UK 8		UK 9		UK 10		UK 11	
ATTENTION: UK 5TH COIN SLOT TIED TO 6TH CHANNEL ON ELEC. COIN MECH		UK 1		UK 2		UK 3		UK 4		UK 5		UK 6		UK 7		UK 8		UK 9		UK 10		UK 11	



Standard Adjustment 18, Game Pricing, continued.

Euro 1-12 Summary & International (Euro) Standard Pricing Select Table

CPU/SOUND PCB DIP SWITCH SW1 SETTING		COUNTRY SETTING OPTION(S)	COIN MECHANISMS (SWITCHES)				PRICING SCHEME				Requires SP Coin Card(s) Part Number		
			COINS THRU ... SLOT:				Number of Plays (Credits) for Price Amount Shown See "Appendix J" for Coin Cards Examples & Info!						
			LEFT	CENTER	RIGHT	3TH							
Pos. 1	2	3	4	5	6	7	8	EUR./EUROPEAN UNION EUROS (1 €)					
ON	S	E	C	R	E	L	O	W	1/0.50				755-5401-01-Y
OFF	S	E	T	T	I	N	G	1/0.50 2/1.00	3/1.50	5/2.00		755-5401-02-Y	
Euro 1-12 are standard settings for use in Europe. See the Euro.													
HIGHLIGHTED		Euro 1						1/0.50	3/1.00			755-5401-03-Y	
= Factory Default		Euro 2						1/0.50 2/1.00	3/1.50	6/2.00		755-5401-04-Y	
HIGHLIGHTED		Euro 3						1/0.50 3/1.00	4/1.50	7/2.00		755-5401-05-Y	
= Not Shown on Coin Card		Euro 4						2/0.50				755-5401-06-Y	
		Euro 5	0.50	1.00	2.00	0.20		1/1.00 2/2.00	3/3.00	5/4.00		755-5401-07-Y	
		Euro 6				optional		1/1.00	3/2.00			755-5401-08-Y	
		Euro 7				optional		1/1.00	2/1.50	3/2.00		755-5401-09-Y	
		Euro 8						1/1.00	3/2.00	7/3.00		755-5401-10-Y	
		Euro 9						1/1.00	4/2.00			755-5401-11-Y	
		Euro 10						2/1.00 4/2.00	6/3.00	9/4.00		755-5401-12-Y	
		Euro 11											
		Euro 12											

For a different Euro Pricing Scheme (other than Factory Default listed below), scroll through Standard Adjustment 18: Euro 1-12 or CUSTOM* for new setting (reference above Euro 1-12 Summary). Keep the Country Dip Switch Setting the same as listed below:

		COUNTRY SETTING OPTION(S)	COIN MECHANISMS (SWITCHES)				PRICING SCHEME				Requires SP Coin Card(s) Part Number	
			COINS THRU ... SLOT:				Number of Plays (Credits) for Price Amount Shown See "Appendix J" for Coin Cards Examples & Info!					
			LEFT	CENTER	RIGHT	3TH						
Pos. 1	2	3	4	5	6	7	8	EUR./EUROPEAN UNION EUROS (1 €)				
ON	▲	▲	▲	▲	▲	▲	▲	1/1.00	2/1.50	3/2.00		755-5401-13-Y
OFF	▼	▼	▼	▼	▼	▼	▼	1/0.50				755-5401-01-Y
Pos. 1	2	3	4	5	6	7	8	EUR./EUROPEAN UNION EUROS (1 €)				
ON	▲	▲	▲	▲	▲	▲	▲	1/1.00	3/2.00			755-5401-06-Y
OFF	▼	▼	▼	▼	▼	▼	▼	1/1.00	3/2.00	7/3.00		755-5401-10-Y
Pos. 1	2	3	4	5	6	7	8	EUR./EUROPEAN UNION EUROS (1 €)				
ON	▲	▲	▲	▲	▲	▲	▲	1/0.50				755-5401-01-Y
OFF	▼	▼	▼	▼	▼	▼	▼	1/0.50 2/1.00	3/1.50	5/2.00		755-5401-02-Y
		GERMANY 3	0.50	1.00	2.00		1/0.50 2/1.00	3/1.50	6/2.00		755-5401-14-Y	
Pos. 1	2	3	4	5	6	7	8	EUR./EUROPEAN UNION EUROS (1 €)				
ON	▲	▲	▲	▲	▲	▲	▲	1/1.00	3/2.00			755-5401-03-Y
OFF	▼	▼	▼	▼	▼	▼	▼	1/0.50				755-5401-01-Y
		ITALY 2	0.50		0.50		1/1.00	3/2.00			755-5401-06-Y	
Pos. 1	2	3	4	5	6	7	8	EUR./EUROPEAN UNION EUROS (1 €)				
ON	▲	▲	▲	▲	▲	▲	▲	1/0.50	3/1.00			755-5401-01-Y
OFF	▼	▼	▼	▼	▼	▼	▼	1/0.50	3/1.00			755-5401-01-Y
Pos. 1	2	3	4	5	6	7	8	EUR./EUROPEAN UNION EUROS (1 €)				
ON	▲	▲	▲	▲	▲	▲	▲	1/0.50				755-5401-01-Y
OFF	▼	▼	▼	▼	▼	▼	▼	1/1.00	3/2.00			755-5401-01-Y
Pos. 1	2	3	4	5	6	7	8	EUR./EUROPEAN UNION EUROS (1 €)				
ON	▲	▲	▲	▲	▲	▲	▲	0.50	1.00	2.00		755-5401-01-Y
OFF	▼	▼	▼	▼	▼	▼	▼	0.50	1.00	2.00		755-5401-01-Y

HIGHLIGHTED = Factory Default **HIGHLIGHTED** = Not Shown on Coin Card

For the associated Coinage Card required if the Factory Default Setting was changed, view on-line at <http://www.sternpinball.com/coinagecards.shtml>

You can download and print the replacement card. Adopt® Reader 5.0 or higher required (link on site). Use Yellow Card Stock: ASTROBRIGHTS® SOLAR YELLOW #65 FROM WAUSAU PAPER PRODUCTS (Stock #22731)

#19 **MATCH PERCENTAGE:** Set between 0% – 10% or OFF. Factory Default = 9%. At 0% the Match Animation Feature occurs at the end of the game but never awards the Match Award (Standard Adjustment 20). Set to OFF, no Match Animation Feature is shown.

#20 **MATCH AWARD:** Set to CREDIT, TICKET* or TOKEN*. Factory Default = CREDIT. This adjustment is not shown if OFF is installed in Match Percentage (Standard Adjustment 19).

* Note: if TICKET or TOKEN is selected, the game will require an optional Ticket or Token Dispenser and then 024 Option (Standard Adj. 55) must be changed accordingly.

#21 **BALLS PER GAME:** Set between 1 – 10. Factory Default = 3. Set the number of balls per game.



To initiate, from the **MAIN MENU**, select the "UTIL" icon. The **UTILITIES MENU** provides ways to quickly and easily customize your game with **Installs** (pre-sets for game Standard & Feature Adjustments), set-up a **Custom Message** (short-cut to Standard Adjustment 41, **Custom Message**), set-up **Custom Pricing** (short-cut to Standard Adjustment 18, to the **Custom Pricing Sub-Menu**), set-up the **Date and Time** (required if the date and time is needed to be accurate for data dumps and for tournaments), reset certain particular game data or perform a complete **Factory Reset** and to download game data, update or backup game code in the **USB MENU**.

All **UTILITIES**, **INSTALLS**, **RESETS MENU** and **USB MENU** icons and their usages are explained throughout this chapter in the same order as seen in the Dot Matrix Display. **NOTE:** Depending on Game Type, Version, selections made, Dip Switch settings, location and/or areas, some icons may appear non-functional or may not appear at all. **Installs (Adjustments), icons and/or functions, order and operation are subject to change. If in doubt use the Factory Default Settings (review Install Factory on the next page).**

In displays where changes can be made or to perform a function, use the **GREEN Button** to go [**BACK**], exit or escape, the **RED Buttons** to [< / -] **MOVE BACK / LEFT** / [+ / >] **MOVE FORWARD / RIGHT** to view the next audit in the group, and the **BLACK Button** to [**SELECT**] the sub-menus.

Go To Installs Menu

To initiate, from the **UTILITIES MENU**, select the "INST" icon. The **INSTALLS MENU** provides 13 **Installs** to vary **Game Play Difficulty** (set with **Feature Adjustments**) or **Game Play Type** and **Install Factory** (restores all adjustments to **Factory Defaults**).

For **detailed customization** or to check current **Adjustments Defaults** (either changed by **YOU** in the **Adjustments Menu** or by this **INSTALLS MENU** or for **Factory Default Settings**), see **Section 3, Chapter 4, GO TO ADJUSTMENTS MENU**. After completing one or more of the **Installs** in this chapter, go back to the **ADJUSTMENTS MENU** to see which **Standard and/or Feature Adjustments** have changed (**Feature Adjustments and/or settings are subject to change during production, and may differ than what is described in the tables at the end of this chapter**). The **Dot Display** will indicate if a setting is a **Factory Default** or not. If the settings are not to your liking, perform one of the following:

- 1.: **Manually change the Standard & Feature Adjustments Settings** (perform this task in the **ADJUSTMENTS MENU**, see the **Adjustments Section**).
- 2.: **Install Factory** (see the last install) on how to reset all of the **Standard & Feature Adjustments** back to the **Factory Default Settings**.

Multiple **Installs can be set** to vary game play; however, for **Installs** that have one or more **Adjustments** in common, the **last "Install" selected & activated**, will **supersede** any previously changed **Adjustment(s)** from any prior **Installs**. Any adjustments which you changed and are not affected by the **Install** will remain as set.

For example, if you want a **5-BALL Game set to EXTRA EASY**: Select and activate the "5BAL" icon first (which will typically change any **Feature Difficulty Adjustments** to **HARD**). then select & activate the "X.EZ" icon to **change back** the **Difficulty Adjustments** to **EXTRA EASY**. However, if the "X.EZ" icon was selected & activated first, then the "5BAL" icon was selected & activated, the game will be set to a **5-BALL Game set to HARD**.

Remember, use the **GREEN Button** to go [**BACK**], exit or escape and the **BLACK Button** to [**SELECT**] to **INSTALL** your new setting(s).



Install Extra Easy

To initiate, from the **INSTALLS MENU**, select the "X.EZ" icon. The **Dot Matrix Display** will indicate the **INSTALL EXTRA EASY**. Follow the on-screen prompts to perform the **Install**. Set the **Game Play Difficulty** level.

Installs Menu continued on the next page.

Installs Menu continued from previous page.



Install Easy

To initiate, from the **INSTALLS MENU**, select the "EASY" icon. The Dot Matrix Display will indicate the **INSTALL EASY**. Follow the on-screen prompts to perform the **Install**. Set the **Game Play Difficulty** level.



Install Medium (Normal or Factory Settings)

To initiate, from the **INSTALLS MENU**, select the "FACT" icon. The Dot Matrix Display will indicate the **INSTALL MEDIUM**. Follow the on-screen prompts to perform the **Install**. Set the **Game Play Difficulty** level.



Install Hard

To initiate, from the **INSTALLS MENU**, select the "HARD" icon. The Dot Matrix Display will indicate the **INSTALL HARD**. Follow the on-screen prompts to perform the **Install**. Set the **Game Play Difficulty** level.



Install Extra Hard

To initiate, from the **INSTALLS MENU**, select the "X.HD" icon. The Dot Matrix Display will indicate the **INSTALL EXTRA HARD**. Follow the on-screen prompts to perform the **Install**. Set the **Game Play Difficulty** level.



Install 3-Ball or 5-Ball

To initiate, from the **INSTALLS MENU**, select either the "3BAL" or "5BAL" icons. The Dot Matrix Display will indicate the **INSTALL 3-BALL** or **5-BALL** depending on choice. Follow the on-screen prompts to perform the **Install**. Set the **Game Play Type** to 3 Balls per game

(Factory Default is 3 Balls per game, not including extra balls earned by the player, if any).



Install Competition

To initiate, from the **INSTALLS MENU**, select the "COMP" icon. The Dot Matrix Display will indicate the **INSTALL COMPETITION**. Follow the on-screen prompts to perform the **Install**. Set the **Game Play Type** to "Tournament" Rules. *Programming varies and is subject to change.*



Install Director's Cut

To initiate, from the **INSTALLS MENU**, select the "DCUT" icon. The Dot Matrix Display will indicate the **INSTALL DIRECTOR'S CUT**. Follow the on-screen prompts to perform the **Install**. Set the **Game Play Type** to programmer's choice. *Programming varies and is subject to change.*



Install Home Play

To initiate, from the **INSTALLS MENU**, select the "HOME" icon. The Dot Matrix Display will indicate the **INSTALL HOME PLAY**. Follow the on-screen prompts to perform the **Install**. Set the **Game Play Type** to "Home" Rules. *Programming varies and is subject to change.*



Install Novelty

To initiate, from the **INSTALLS MENU**, select the "NOV" icon. The Dot Matrix Display will indicate the **INSTALL NOVELTY**. Follow the on-screen prompts to perform the **Install**.

***** This setting is recommended where local laws restrict certain game features. *****

Set the **Game Play Type** to "Restricted" Rules. *Programming varies and is subject to change.*



Install Add-A-Ball

To initiate, from the **INSTALLS MENU**, select the "A.A.B." icon. The Dot Matrix Display will indicate the **INSTALL ADD-A-BALL**. Follow the on-screen prompts to perform the **Install**.

***** This setting is recommended where local laws restrict certain game features. *****

Set the **Game Play Type** to "Restricted" Rules. *Programming varies and is subject to change.*



Install Factory

To initiate, from the **INSTALLS MENU**, select the "FACT" icon. The Dot Matrix Display will indicate the **INSTALL FACTORY**. Follow the on-screen prompts to perform the **Install**. **CAUTION!** All **Standard and Feature Adjustments** which were changed in the **INSTALLS MENU** or **ADJUSTMENTS MENU** are returned to the **Factory Defaults** (as indicated in the Dot Display in the **ADJUSTMENTS MENU**). *Note: To perform a complete Factory Reset, GO TO THE RESETS MENU. Escape back to the UTILITIES MENU, select the "RESET" icon, then select the "FACT" icon in the RESETS MENU (review the end of this section, Reset*

Factory Settings).



Enter Custom Message

To initiate, from the **UTILITIES MENU**, select the "ABCD CUST MSG" icon. The **SET CUSTOM MESSAGE** (a short-cut for Standard Adjustment 41, **Custom Message**) provides an opportunity to have a text message appear in the the **Attract Mode**. Follow the on-screen prompts to complete [END].

Remember, use the **GREEN Button** to go [**BACK**], exit or escape, the **RED Buttons** to [</-] MOVE LEFT / CHOOSE NEXT [+/>] MOVE RIGHT / CHOOSE PREVIOUS, and the **BLACK Button** to [**SELECT**] as 'OK'.



Set Custom Pricing

To initiate, from the **UTILITIES MENU**, select the "PRIC" icon. The **CUSTOM PRICING MENU** (a short-cut for Standard Adjustment 18, **Game Pricing**, and selling selected is **CUSTOM**) provides an opportunity to set **Custom Pricing**.

Note! **MONETARY AMOUNT MUST BE SELECTED FIRST!** Press [**BACK**] to - DECREASE or [**SELECT**] to + INCREASE the [<\$>] monetary amount (e.g. look at the right side of the display from \$0.25 to \$0.50). Press [</-] to - DECREASE or [+/>] to + INCREASE the credit quantity (e.g. look at the left side of the display from 0 CREDITS AT: to 1 CREDIT AT:).

IF EXAMPLE CUSTOM PRICING SETTING DESIRED IS :

1 Play for \$0.50, 3 Plays for \$1.00 and 7 Plays for \$2.00

THEN YOU WILL NEED TO PERFORM THE FOLLOWING :

REMINDER
to these menus:

Press [**BACK**] to - DECREASE [<\$>]

Press [**SELECT**] to + INCREASE [\$>]

Step 1 The starting display appears as below if no prior **Custom Pricing** was installed,

CUSTOM PRICING	
0 CREDITS AT:	\$0.25
USE -/+ TO CHANGE CREDITS	

Step 2 Press [**SELECT**] to + INCREASE to \$0.50. Press [+/>] to + INCREASE to 1 CREDIT AT:

CUSTOM PRICING	
1 CREDIT AT:	\$0.50
1/0.50	
USE -/+ TO 'INSTALL'	

Step 3 Press [**SELECT**] to + INCREASE to \$1.00. Press [+/>] to + INCREASE to 2 CREDITS AT:

CUSTOM PRICING	
2 CREDITS AT:	\$1.00
1/0.50 3/1.00	
USE -/+ TO CHANGE CREDITS	

Step 4 Press [**SELECT**] to + INCREASE to \$2.00. Press [+/>] to + INCREASE to 4 CREDITS AT:

CUSTOM PRICING	
4 CREDITS AT:	\$2.00
1/0.50 3/1.00 7/2.00	
USE -/+ TO CHANGE CREDITS	

Step 5 Press [**SELECT**] to + INCREASE the amount once (example = \$2.25).

CUSTOM PRICING	
0 CREDITS AT:	\$2.25
1/0.50 3/1.00 7/2.00	
USE -/+ TO 'INSTALL'	

Press [</-] once or press [+/>] eleven times until **INSTALL** appears.

Step 6 Press [**SELECT**] to **INSTALL**. Press [</-]/[+/>] or [**BACK**] to edit.

CUSTOM PRICING	
INSTALL	
1/0.50 3/1.00 7/2.00	
PRESS 'SELECT' TO INSTALL	

Step 7 Press [**SELECT**], press [**BACK**] twice to exit the **SERVICE MENU** with your **Custom Pricing** installed.

CUSTOM PRICING	
INSTALLED	
PRESS 'SELECT' TO CONTINUE	

To correct or make new changes, reenter, which brings you to **Step 6**. Press [**BACK**] repeatedly until the monetary amount shown is the desired amount and then continue following the above steps with your new or corrected settings. If you are still having difficulty or if you have any questions, please call **Technical Support** 800-542-5377 or 708-345-7700, option 1.



Set Date / Time

To initiate, from the **UTILITIES MENU**, select the "TIME" icon. The **SET TIME MENU** appears with the **MONTH** flashing. Setting the date and time is required for 'Data Dumps' and Tournament Start and End Dates. If the setting of Standard Adjustment 61, **Time Format**, is set to **12-HOUR (Factory Default)** the time will be expressed in the **AM / PM** format. If Standard Adjustment 61, **Time Format**, is set to **24-HOUR** the time will be expressed in the **24-hour** format.



Go To Resets Menu

To initiate, from the **UTILITIES MENU**, select the "RESET" icon. The **RESETS MENU** provides six (6) functions to reset *only the Coin Audits*, reset *only the Game Audits*, reset *only the Grand Champion Score*, reset *only the High Score(s)*, reset *only the paid Credits (includes Service Credits)* or to reset **ALL DATA** back to the **Factory Default Settings**.



Reset Coin Audits

To initiate, from the **RESET MENU**, select the "COIN" icon. **▲ ONLY the Coin Audits** [Earnings Audits 5-12], will be reset to zero (0), **Factory Default Settings**. Follow the on-screen prompts to perform the **Reset**.



Reset Game Audits

To initiate, from the **RESET MENU**, select the "AUD" icon. **▲ ONLY the Game Audits** [Earnings Audits 1-4, Standard Audits 1-59 and Feature Audits 1-XX*], will be reset to zero (0), **Factory Default Settings**. Follow the on-screen prompts to perform the **Reset**. *varies per game title.



Reset Grand Champion (Score)

To initiate, from the **RESET MENU**, select the "GC" icon. **▲ ONLY the Grand Champion Score** [adjustable via Standard Adjustment 31], will be reset to **Factory Default Setting**. Follow the on-screen prompts to perform the **Reset**.



Reset High Scores

To initiate, from the **RESET MENU**, select the "HSTD" icon. **▲ ONLY the High Score(s)** [adjustable via Standard Adjustments 32-35], will be reset to **Factory Default Setting(s)**. Follow the on-screen prompts to perform the **Reset**. **Note:** *High Scores (but not Grand Champion Score) are reset automatically every 2,000 games (Factory Default Setting) [adjustable via Standard Adjustment 37, HSTD Reset Count]*.



Reset Credits

To initiate, from the **RESET MENU**, select the "CRED" icon. **▲ ONLY the Credits (includes Service Credits)** [adjustable via Standard Adjustment 23, **Credit Limit**], will be reset to zero (0), **Factory Default Settings**. Follow the on-screen prompts to perform the **Reset**.



Reset Factory Settings

To initiate, from the **RESET MENU**, select the "FACT" icon. **▲ ALL GAME DATA IS RESET!** (with the exception of *Earnings Audit 13, Software Meter*). **NOTE: IF YOU HAD SET-UP CUSTOM PRICING OR HAD CHANGED ANY ADJUSTMENTS OR PERFORMED INSTALLS, IT IS SUGGESTED TO WRITE DOWN YOUR CHANGES PRIOR TO THE FACTORY RESET.** Follow the on-screen prompts to perform the **Reset**.



Go To USB Menu

To initiate, from the **UTILITIES MENU**, select the "USB" icon. The **USB MENU** provides three (3) functions to download game data, update your game code or backup your code onto a USB Memory Stick. *Review the inside cover for information on how to update your game code.*



Update Game Code

To initiate, from the **USB MENU**, select the "UPDT" icon. Follow the on-screen prompts or review the inside cover for more information.



Dump Audits to USB

To initiate, from the **USB MENU**, select the "DUMP" icon. Follow the on-screen prompts to perform a **Data Dump** (download). **Note:** *If icon is not present, access via the Audits Menu, see the Audits Section.*

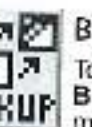

Backup to USB Memory Stick

To initiate, from the **USB MENU**, select the "BKUP" icon. Follow the on-screen prompts to perform a **Backup** (game code only). This backup feature does not retain adjustments and/or settings changes made.



To initiate, from the **MAIN MENU**, select the "TOUR" icon. The **TOURNAMENT MENU** provides ways to quickly and easily start and stop a tournament. Also, tournament data can be viewed (*audits, prize info, etc.*).

All **TOURNAMENT MENU** icons and their usages are explained throughout this chapter in the same order as seen in the Dot Matrix Display. **NOTE:** Depending on Game Type, Version, selections made, Dip Switch settings, location and/or areas, some icons may appear non-functional or may not appear at all. **Icons and/or functions, order and operation are subject to change.**

In displays where changes can be made or to perform a function, use the **GREEN Button** to go [**BACK**], exit or escape, the **RED Buttons** to [< / -] **HIGHLIGHT PREVIOUS** or **DECREASE** / [+ / >] **HIGHLIGHT NEXT** or **INCREASE** to highlight the desired option, and the **BLACK Button** to [**SELECT**] it or activate.

Start Tournament

To initiate, from the **TOURNAMENT MENU**, select the "START" icon. The **START TOURNAMENT MENU** allows the operator to start a tournament. Select **QUICK START** or **CUSTOM** Tournament Start. For the first time Tournament Set-Up, it is recommended to select **CUSTOM**. Follow the on-screen prompts.

After completion of all options in **QUICK START** or **CUSTOM**, the Tournament is started, the **START TOURNAMENT MENU** is exited and returns to the **TOURNAMENT MENU**.

QUICK START :

Increase or decrease the: • **DAYS, HOURS and MINUTES** • **PRIZE POOL \$ (DOLLAR) and ¢ (CENT) AMOUNT**
• **INCREMENT THE PRIZE POOL PER PLAY INCREASES \$ and ¢ AMOUNT**

CUSTOM START :

- Confirm the current date and time (if it was not set previous via the **UTILITIES MENU** it can be set-up in this display as well). Enter the **MONTH, DAY, YEAR** and **TIME**
- Choose the Tournament **Start Date: MONTH, DAY, YEAR** and **TIME**
- Choose the Tournament **End Date: MONTH, DAY, YEAR** and **TIME**
- Choose the **CREDITS** per play desired (01-10). Set the maximum number of Credits that may be accumulated per game. **Note:** The current pricing is displayed; to change pricing **GO TO THE ADJUSTMENTS MENU**.

Increase or decrease the: • **PRIZE POOL \$ (DOLLAR) and ¢ (CENT) AMOUNT**

- **INCREMENT THE PRIZE POOL PER PLAY INCREASES \$ and ¢ AMOUNT**
- **MAXIMUM (CAP) PRIZE POOL \$ and ¢ AMOUNT.**

- Increase or decrease the number of **PRIZES** (01-05 **HIGH SCORE**; 02-05 **B'N'W**). Set the maximum # of Prize Positions to be awarded during a Tournament. **Selections are as follows** (% distribution cannot be changed):

	HIGH SCORE:					BUMP N' WIN :																	
Set to 01	1 Winner	100%	(1)	Prize Pool		Cannot set to 01.	Minimum of 2 winners required.																
Set to 02	2 Winners	65%	(1)	35%	(2)	Set to 02	2 Winners	65%	(1)	35%	(2)												
Set to 03	3 Winners	50%	(1)	30%	(2)	20%	(3)	Set to 03	3 Winners	50%	(1)	25%	(2)	25%	(3)								
Set to 04	4 Winners	50%	(1)	25%	(2)	15%	(3)	10%	(4)	Set to 04	4 Winners	40%	(1)	20%	(2)	20%	(3)	20%	(4)				
Set to 05	5 Winners	50%	(1)	20%	(2)	15%	(3)	10%	(4)	5%	(5)	Set to 05	5 Winners	40%	(1)	15%	(2)	15%	(3)	15%	(4)	15%	(5)

- Select the **AWARD TYPE** (**CASH, POINTS, PRIZE, TICKETS** or **NONE**). Select **CASH** for the displays to represent the Prize Pool amount (based on **Jackpot Base and Max.**) in **\$Dollars**. Select **POINTS** for the display to represent the Prize Pool amount in **Points**. Select **PRIZE**, if applicable. Select **TICKET** for the display to represent the Prize Pool amount in **Tickets**. Select **NONE NOT TO** represent anything.

POWER REQUIREMENTS



This game *must be connected to a properly grounded outlet to reduce shock hazard and insure proper game operation. See the Yellow Pages (Schematics & Wiring), for transformer connections required for Normal, High, and Low Line conditions.*



Normal Line:		110v AC - 125v AC @ 60Hz	
Domestic Use 6T 8AMP 250v Slo-Blo Fuses.	AVG OPERATION	MAX OPERATION	
	CURRENT: 2.8AMP WATTAGE: 329w	CURRENT: 8AMP WATTAGE: 940w	
High Line:		218v AC - 240v AC @ 50Hz	
Export Use 2x 5AMP 250v Slo-Blo Fuses. <small>(England & Hong Kong use an 11amp 250v SB Fuse)</small>	AVG OPERATION	MAX OPERATION	
	CURRENT: 1.8AMP WATTAGE: 412w	CURRENT: 5AMP 8AMP* WATTAGE: 1145w 1832w*	Eng and Hong Kong use 11amp SB Fuse
Low Line:		95v AC - 108v AC @ 50Hz / 60Hz	
Export Japan Only Use 6T 8AMP 250v Slo-Blo Fuses.	AVG OPERATION	MAX OPERATION	
	CURRENT: 2.6AMP WATTAGE: 264w	CURRENT: 8AMP WATTAGE: 812w	

GAME DIMENSIONS

TRANSPORTATION

The overall Front / Back Height dimensions include the added 1" with the *Leg Levelers* turned all the way in.

*** PLEASE NOTE:** The *TOURNAMENT PLAY Sign* or *betaBRITE Color Dot Display* will add up to 4 3/8" to the overall Back Height for a total of 79 1/4".

Ceiling Height Requirement:
 An additional 1 1/2" is required for the rotation (⊞) of the Backbox to the upright position.

The complete Back Height required with Sign or Dot Display and rotation: 81"

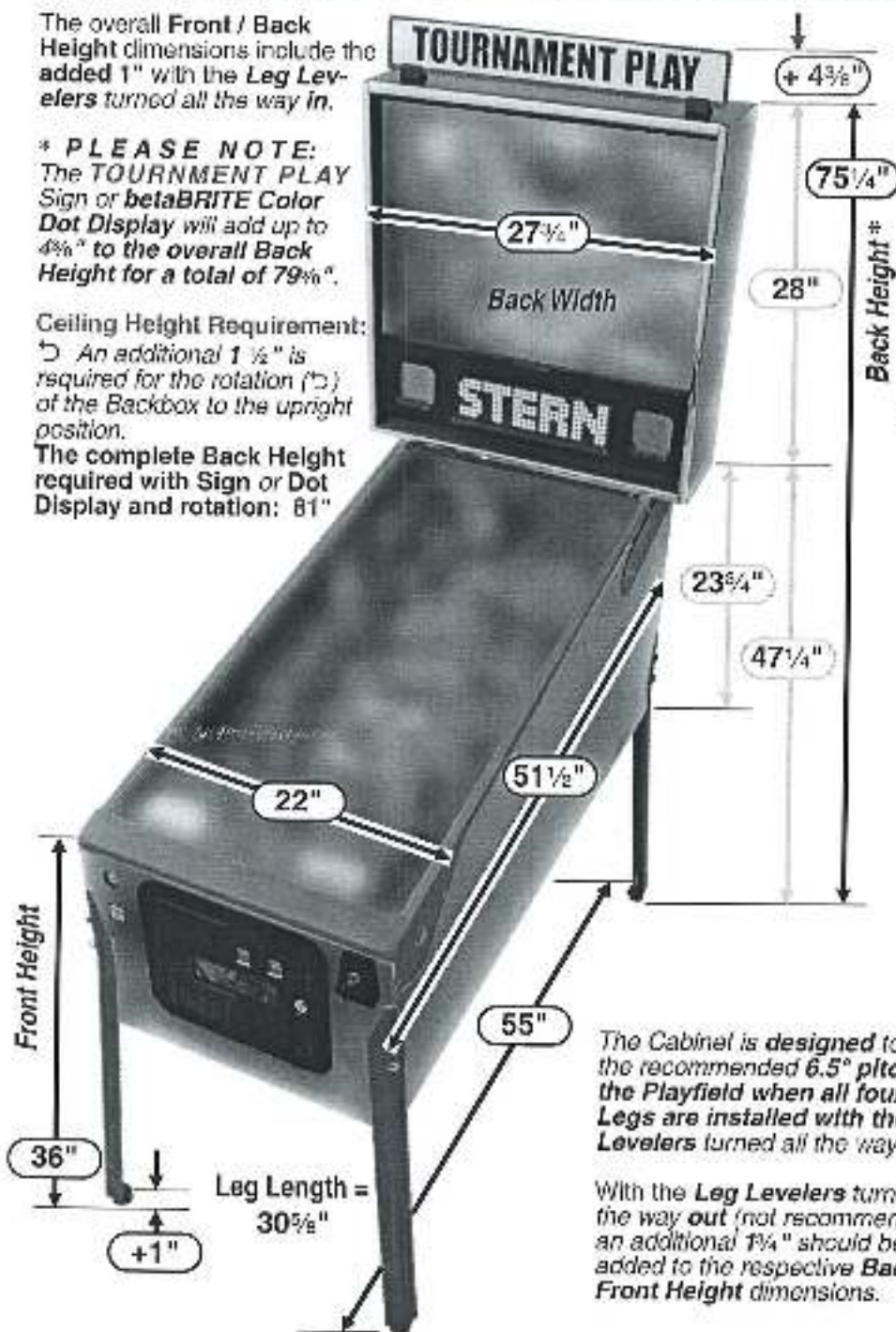

BEFORE TRANSPORTING



To reduce the possibility of damage, observe ALL precautions whenever transporting the game.

Read & follow the next page on How to Secure the Backbox for Transporting. Remove the legs and secure the game within the transporting vehicle.

SAVE AND RETAIN ALL PRINTED INFORMATION INSIDE THE CABINET!



The Cabinet is designed to give the recommended 6.5° pitch to the Playfield when all four (4) Legs are installed with the Leg Levelers turned all the way in.

With the Leg Levelers turned all the way out (not recommended), an additional 1 1/4" should be added to the respective Back or Front Height dimensions.

How to Secure the Backbox for Transporting

For more Backbox details & part numbers, see the Pink Pages (Parts Identification & Location, Backbox ...).

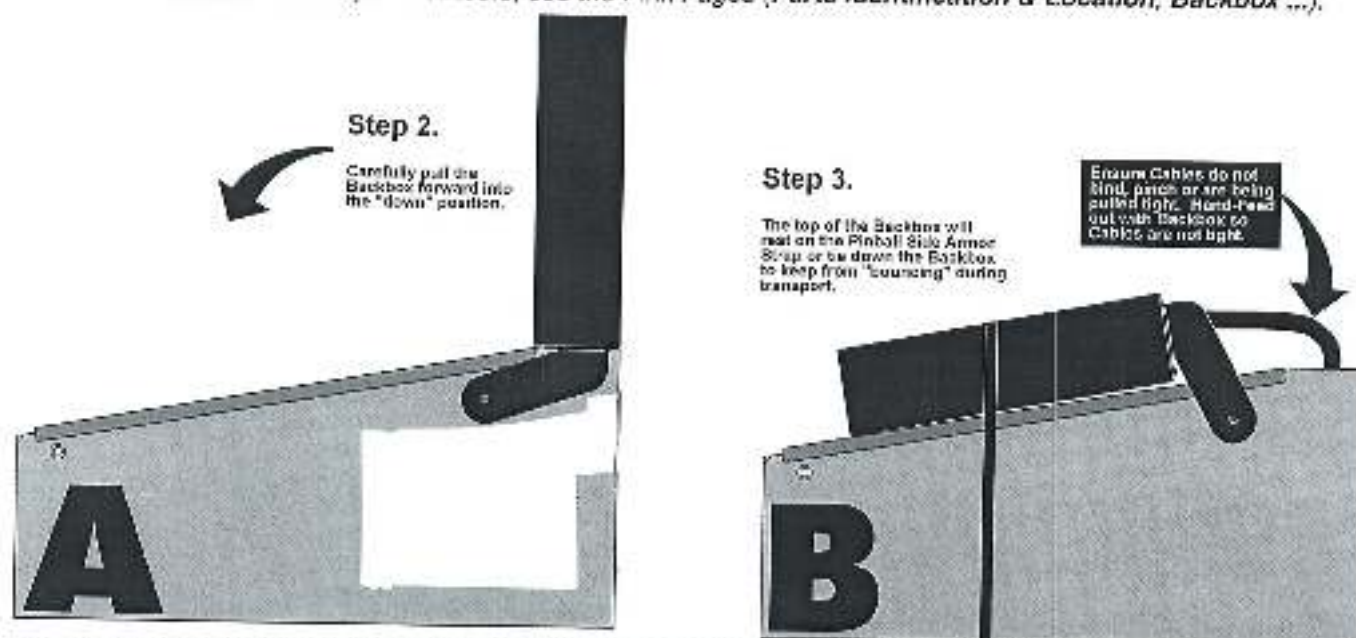

Leg Leveler Adjustment

Attach the four (4) Leg Assemblies to cabinet corners with the eight (8) leg bolts provided.

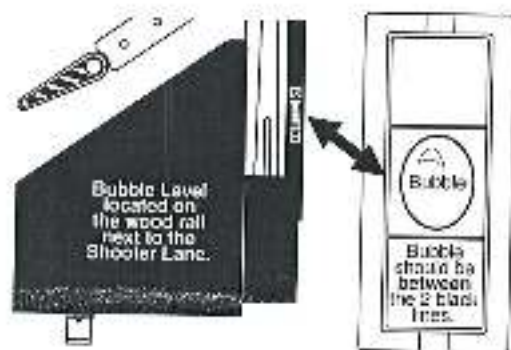

Start adjustment with the leg levelers turned all the way in.

View the bubble in the level provided on the right side wood rail.

Adjust the front or rear levelers as necessary to cause the bubble to float between the two (2) black lines.

Use a pinball to roll down the center of the playfield for side-to-side leveling.

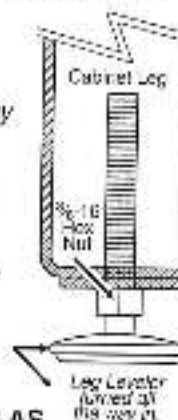

YOUR PLAYFIELD PITCH IS NOW AT 6.5° AS REQUIRED FOR PROPER GAME PLAY!

Note: For custom adjustment greater than 6.5° can be achieved by turning out the rear leg leveler(s), however, it is not recommended.

Easy Access Service System - 2 Positions

With the front molding & glass removed, carefully lift the playfield (take care when using the Bottom Arch to hoist).

Position 1

When lifted high enough, the **Playfield Support Slide Brackets** (Fig. 1A) can be seen and can clear the cabinet front (Fig. 1B). At this time, pull the playfield toward the front of the cabinet, checking that the mechanical components clear the cabinet front, then rest the playfield on the **Playfield Support Slide Brackets** at the front channel of cabinet (Fig. 1C);

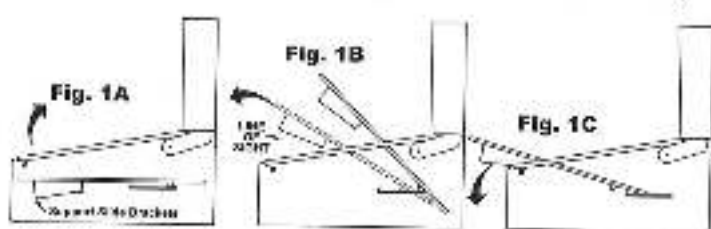

Position 2

With the playfield at rest, hold the sides & pull toward the front of the cabinet (approx. 6" to 8"), until resistance is felt from **Edge Slide Brackets** stopping against the **Slide & Pivot Support Brackets** located on either side of the cabinet (Fig. 2A). At this time, swivel the playfield toward the Backbox, then rest on the top edge (Fig. 2B & 2C).

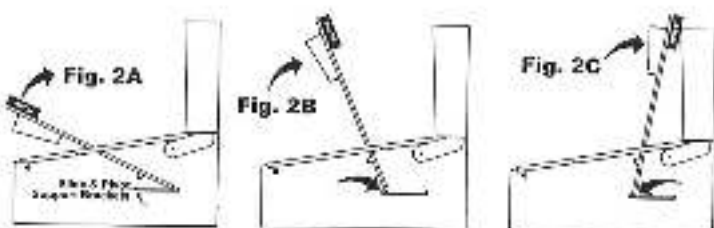

Game Name	CPU Bd. No.	I/O PWR DRV Bd. No.	U9 Pinball Boot ROM
World Poker Tour	520-5246-00	520-5249-00	V3.1
Pirates Of The Caribbean	520-5246-00	520-5249-00	V3.1
Family Guy	520-5246-00	520-5249-00	V3.1
Spider-Man	520-5246-00	520-5249-00	V3.1
Wheel Of Fortune	520-5246-00	520-5249-00	V3.1
NBA	520-5246-00	520-5249-00	V3.1
CSI	520-5246-00	520-5249-00	V3.1
Batman	520-5246-00	520-5249-00	V3.1
Indiana Jones	520-5246-00	520-5249-00	V3.1
Shrek	520-5246-00	520-5249-00	V3.1
24	520-5246-00	520-5249-00	V3.1
Avatar	520-5246-00	520-5249-00	V3.1
Big Buck Hunter	520-5246-00	520-5249-00	V3.1
Iron Man	520-5246-00	520-5249-00	V3.1
The Rolling Stones	520-5246-00	520-5249-00	V3.1
Tron	520-5246-00	520-5249-00	V3.1
Avatar L/E	520-5303-03	520-5249-00	V3.1
The Rolling Stones L/E	520-5303-03	520-5249-00	V3.1
Tron L/E	520-5303-03	520-5317-00	V3.1
Transformers	520-5246-02	520-5249-00	V2.0
Transformers L/E	520-5303-04	520-5317-00	V2.0
AC/DC	520-5337-01	520-5249-00	AC/DC 1.0
AC/DC (L/E)	520-5337-00	520-5317-00	AC/DC 1.0
X-MEN	520-5246-02	520-5249-00	V2.0
X-MEN (L/E)	520-5303-04	520-5317-00	V2.0
Avengers	520-5246-02	520-5249-00	V2.0
Avengers L/E	520-5303-04	520-5317-00	V2.0
Metallica	520-5337-01	520-5249-00	V1.0
Metallica L/E	520-5337-00	520-5317-00	V1.0
Star Trek	520-5352-00	520-5249-00 (REV. D)	V1.0 (64M)
Star Trek L/E	520-5352-01	520-5317-00	V1.0 (64M)
Mustang	520-5352-00	520-5249-00 (REV. D)	V1.0 (64M)
Mustang L/E	520-5352-01	520-5249-00 (REV. D)	V1.0 (64M)
Batman (Standard)	520-5303-00	520-5249-00	V3.1
Iron Man (Classic)	520-5303-01	520-5304-00	Not Used
The Simpsons Kooky Carnival (RED)	520-5246-00	520-5249-00	V3.1

Playfield - Rubber Parts Black ■, White □ & Blue ■ (Rings Actual Size) †

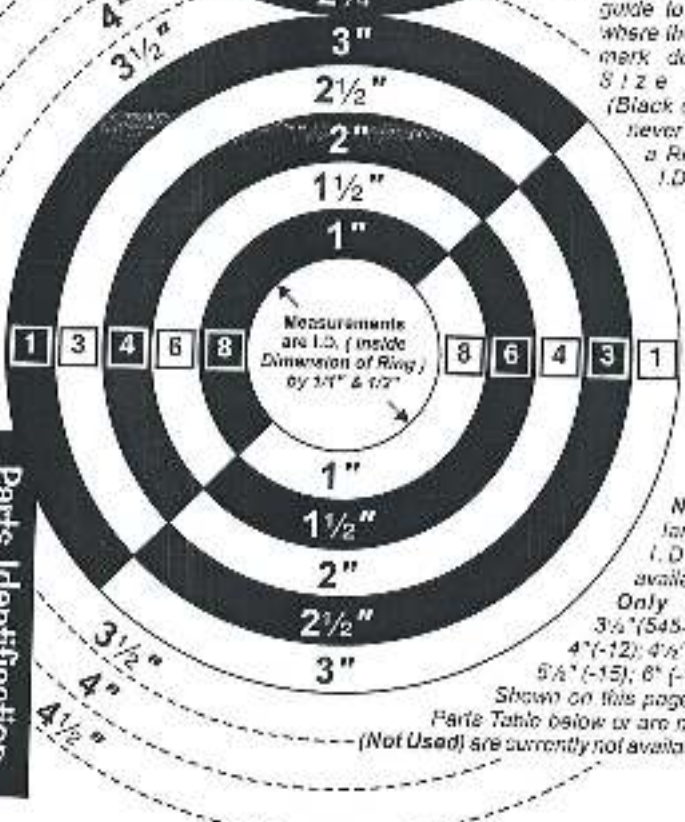
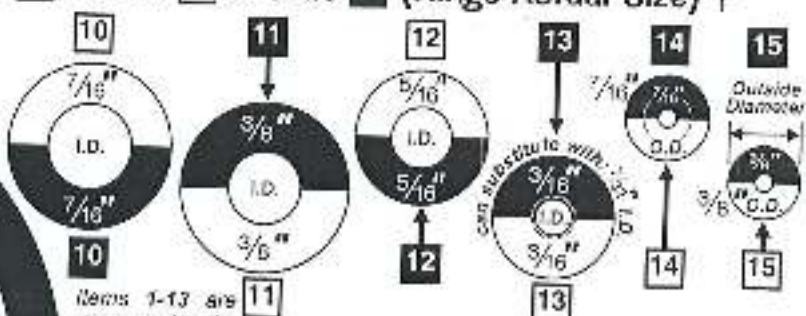
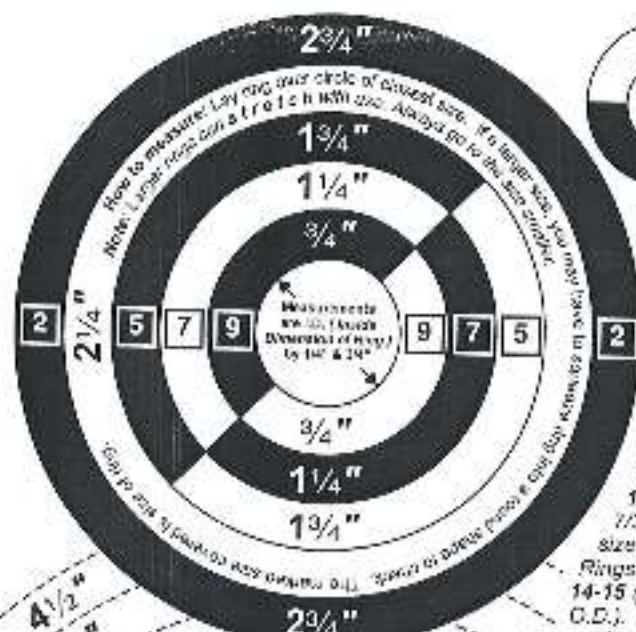

Items 1-13 are measured by the inside diameter (I.D.). Items 1-9 and 11 are approximately 1/4 inch thick, items 10, 12-15 are approximately 3/16 inch thick. Item 13 can also be a 1/32 inch I.D. Ring. The size is imprinted on all Rings except for items 14-15 (7/16 inch O.D. & 3/8 inch O.D.). Use this page as a guide to measure rings where the size imprint or mark does not exist. Size 2 1/4 inch I.D. (Black or White) was never used. Choose a Ring Size +/- 1/4 inch I.D. if required.

Note: Sizes larger than 3 inch I.D. currently available in Black Only (Not Used): 3 1/4 inch (545-5348-11); 4 inch (-12); 4 1/2 inch (-13); 5 inch (-14); 5 1/2 inch (-15); 6 inch (-16). Sizes Not Shown on this page, listed in the Parts Table below or are noted with NU (Not Used) are currently not available.

Nr.	RUBBER RINGS	QTY.	SPI PART Nr.
1	3" I.D. Rubber Ring BLACK	2	545-5348-10
	3" I.D. Rubber Ring WHITE		545-5348-00
2	2 3/4" I.D. Rubber Ring BLK		545-5348-20
		NU	
3	2 1/2" I.D. Rubber Ring BLK	2	545-5348-09
	2 1/2" I.D. Rubber Ring WHT		545-5348-09
4	2" I.D. Rubber Ring BLACK		545-5348-08
	2" I.D. Rubber Ring WHITE		545-5348-08
5	1 3/4" I.D. Rubber Ring BLK		545-5348-21
		NU	
6	1 1/2" I.D. Rubber Ring BLK		545-5348-07
	1 1/2" I.D. Rubber Ring WHT		545-5348-07
7	1 1/4" I.D. Rubber Ring BLK	3	545-5348-06
	1 1/4" I.D. Rubber Ring WHT		545-5348-06
8	1" I.D. Rubber Ring BLACK	4	545-5348-05
	1" I.D. Rubber Ring WHITE		545-5348-05
9	3/4" I.D. Rubber Ring BLACK	2	545-5348-04
	3/4" I.D. Rubber Ring WHITE		545-5348-04
10	7/16" I.D. Rubber Ring BLK		545-5348-18
	7/16" I.D. Rubber Ring WHT		545-5348-08
11	3/8" I.D. Rubber Ring BLACK		545-5348-03
		NU	
12	5/16" I.D. Rubber Ring BLK	7	545-5348-02
	5/16" I.D. Rubber Ring WHT		545-5348-52
13	3/16" I.D. Rubber Ring BLK	4	545-5348-01
	3/16" I.D. Rubber Ring WHT		545-5348-51
14	7/16" O.D. Rubber Ring BLK	10	545-5348-17
	7/16" O.D. Rubber Ring WHT		545-5348-07
		NU	
15	3/8" O.D. Rubber Ring BLK		545-5348-19
	3/8" O.D. Rubber Ring WHT		545-5348-06
16	Small Flipper BLACK Ring (Soft Duro)		545-5277-00
	Small Flipper RED Ring (Soft Duro)		545-5277-22
	Large Flipper BLACK Ring (Soft Duro)	2	545-5277-00
	Large Flipper YELLOW Ring (Soft Duro) (use .68 .40 Duro)		545-5277-04
	Large Flipper WHITE Ring (Soft Duro)		545-5277-08
	Large Flipper RED Ring (Soft Duro)		545-5277-22

Take Note:

For Blue Rubber Pads, see the next page and/or the Blue Pages for the assembly the pads are found on for the part number.

Nr.	RUBBER BUMPER PADS	QTY.	SPI PART Nr.
A*	Bumper BLK Pad (Lg. w/ grommet)	4	545-5426-00
	*Item A are located on Flipper Assembly. See next page for location.		
B*	Bumper BLK Pad (Sm. w/ grommet)		545-6105-00
	*Item B are located on multiple assemblies. See next page for location.		

Nr.	RBR. BUMPER POST SLVS.	QTY.	SPI PART Nr.
D*	Bumper BLACK Post Sleeve (Tall)		545-5308-05
	*Item D is RED use 545-5308-22; Item D is WHITE use 545-5308-06.		
E*	Bumper Post Sleeve (Short)		545-6151-00

7 BAYONET 112-5034-02 LED(RED)



15 WEDGE BASE 112-5033-08
8 BAYONET 112-5034-08

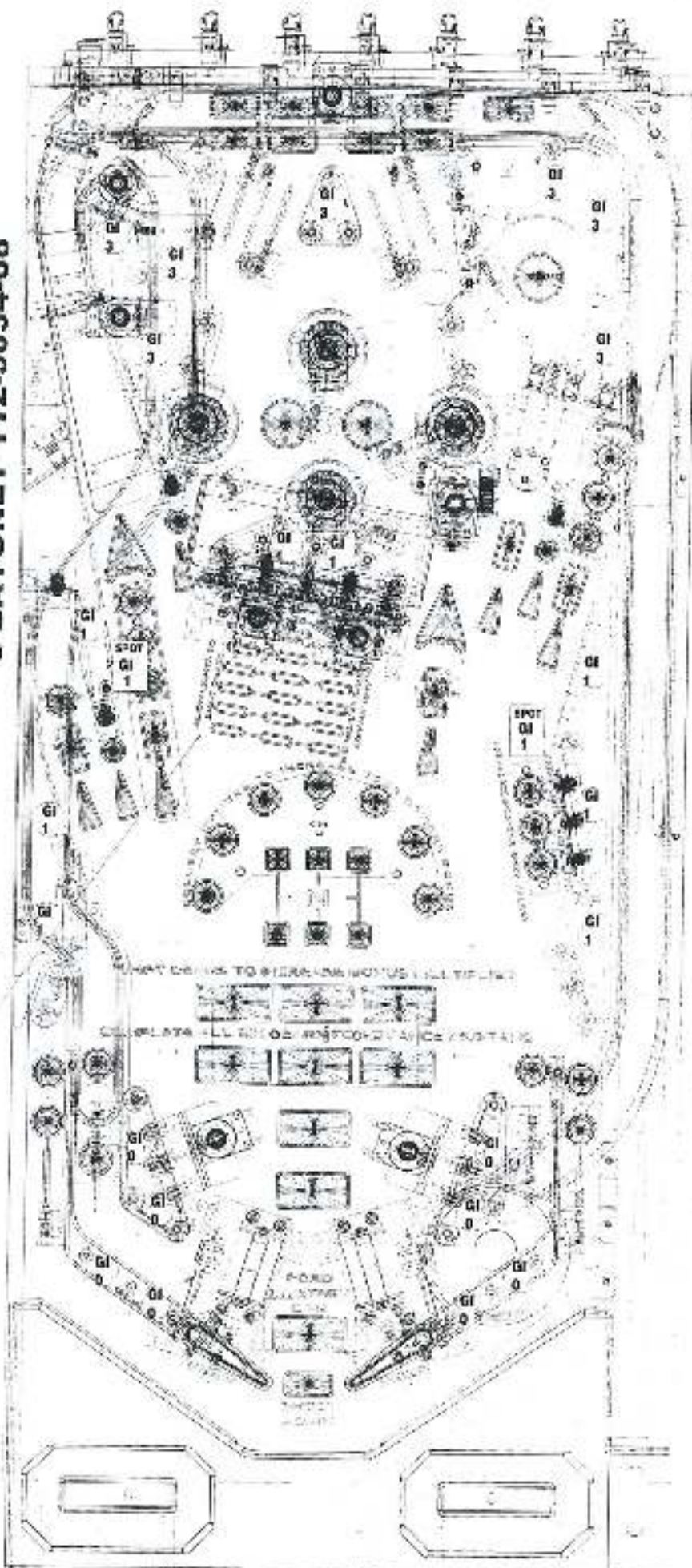

112-5034-02 (RED)
112-5034-08 (RED)

BOARD 5

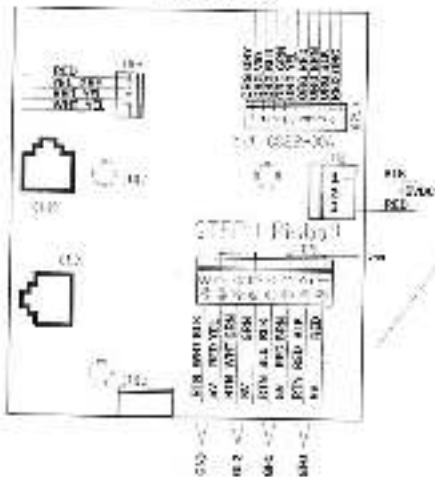

G/I MAP

DTS LAMP

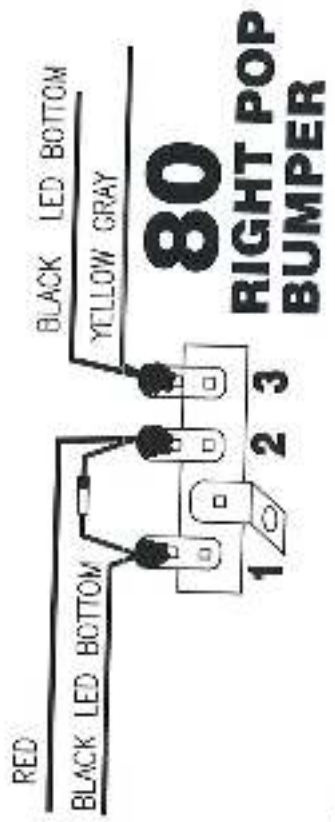
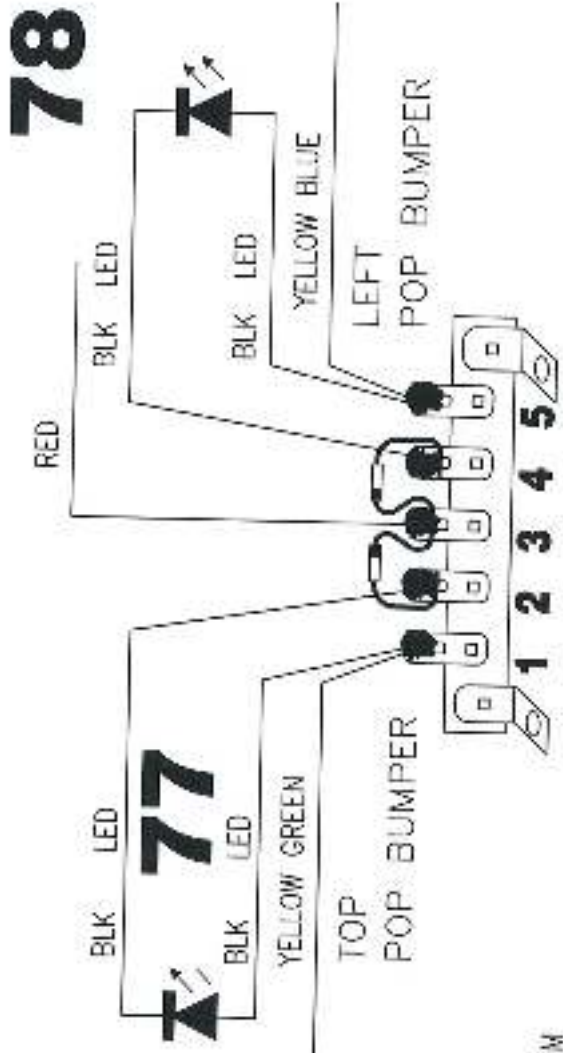
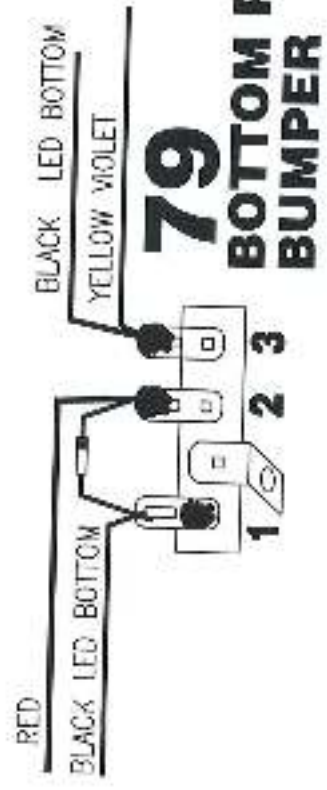

DRAWN REYNA	DATE 12-11-13	TITLE DTS Configuration
1st USE	SCALE 1:1	MUSTANG(PRO)
Stern Pinball, Inc 2020 JANICE AVE., MELROSE PARK, IL 60160		PART NO. DTS-MAP

(A)
(C)

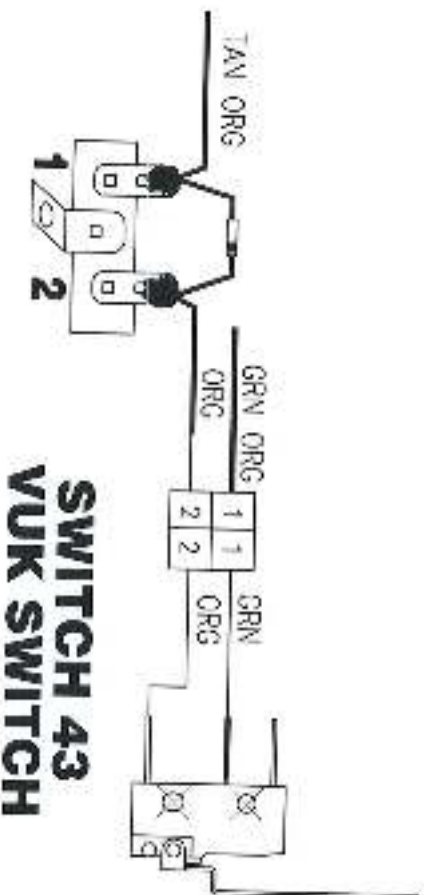

**SWITCH 43
VUK SWITCH**

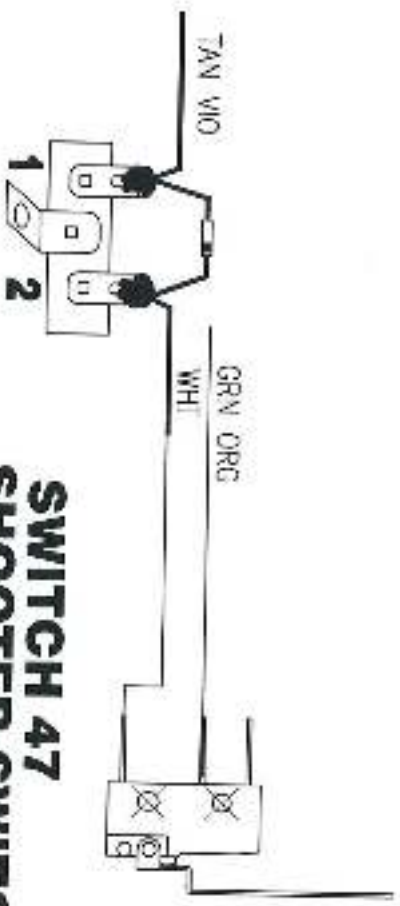

**SWITCH 47
SHOOTER SWITCH**

QWY	REV	DATE	TITLE
1st USE	REYNA	01-10-14	DTS Configuration
		SCALE 1:1	MUSTANG (PRO)
Stern Pinball, Inc 2020 JANICE AVE., MELROSE PARK, IL. 60160			PART NO. DTS-MAP

MUSTANG PRO Opto Amplifier Board Wiring Configuration

Transceiver Boards
500-6775-01

Switch 39

Amplifier Board #
520-5239-01

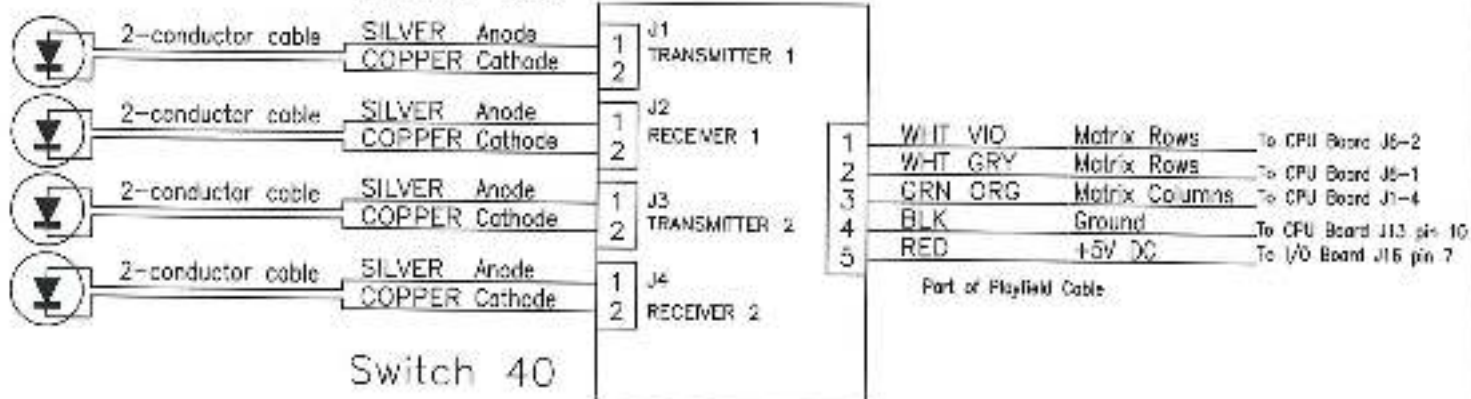

Date: 12-11-13	TITLE
Scale: N/S	Rev: -
Opto Amplifier Board Wiring	
STERN PINBALL, INC.	OWN. REYNA
	1st USE MUSTANG

47

Use the data cable! should be disconnected when programming to prevent conflicts. Use the programmer as the data bus. VISP from the programmer is connected to RXD2 to ensure the K6488 transmitter won't conflict during programming.

- 1) drive nRSTn Low
- 2) drive nTRP Low
- 3) release nRSTn (float, pulled high)
- 4) demarked zero count
- 5) release nTRP (float, pulled high)
- 6) drive nRSTn Low
- 7) release nRSTn (float, pulled high)

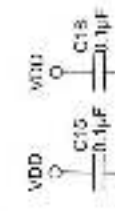

VBB=48V
 VNB=8V
 VLED=6V
 VCC=5V
 VDD=3.3V

LPC1112 inputs are 5V tolerant when not configured as ADC

PC0.4 HIGH INDICATES USB ARMED. STEPS 14-8 PROGRAMMER'S REFRESH THE SWR FOR 25 TIME LOG.

CODE ADDRESS COORDS:
 PC0.11: 33 (3-BARD STRAP, 1: SERIAL#261)
 PC1.2: 52
 PC1.4: 31
 PC0.5: 30
 SAID NEEDED TO ADDRESS 5

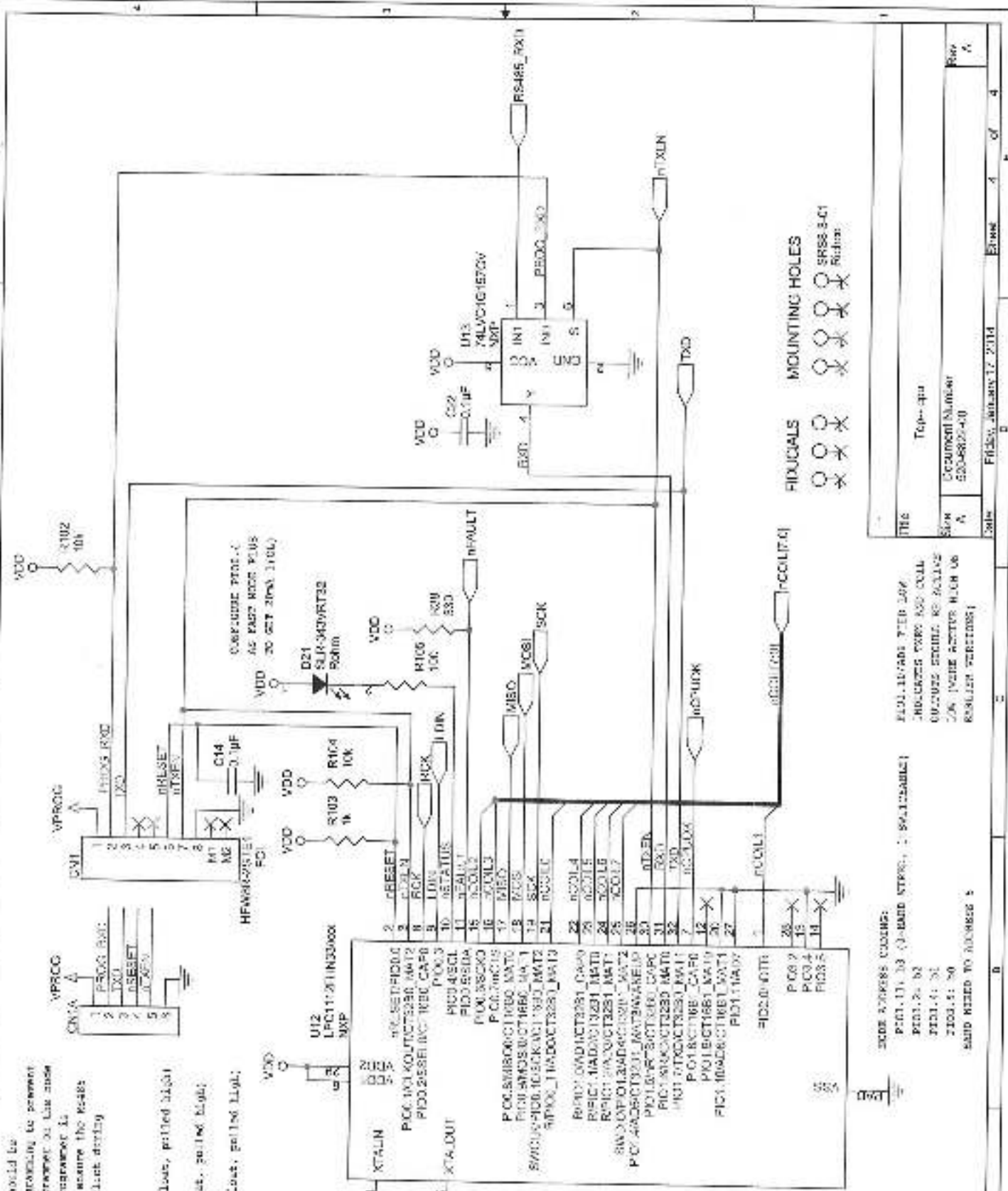

FIDUCIALS MOUNTING HOLES

 SRSS 5-CT
 Rfiduc

Rev	A	Document Number	600-6825-4-0
File	FR655	Date	January 17, 2014
Page	1	Sheet	1 of 4

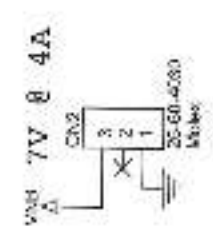
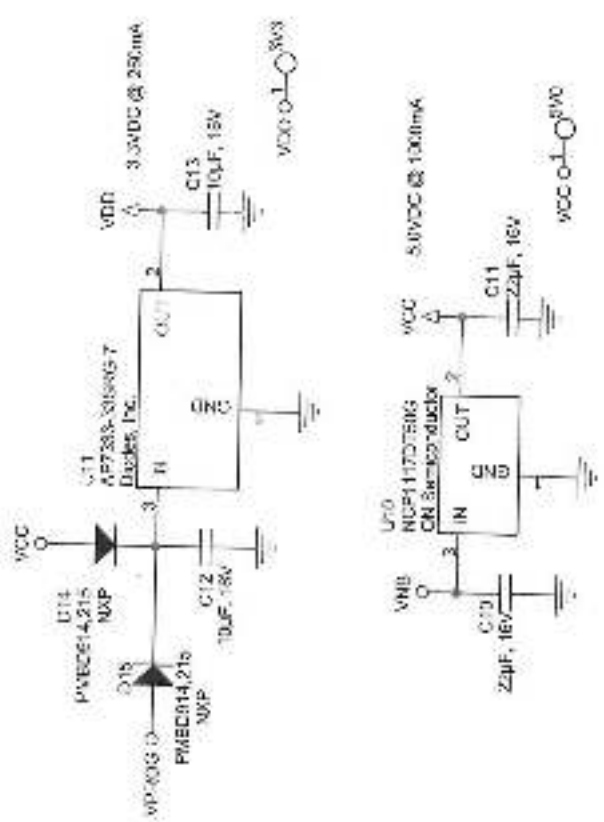

Title		- power supply	
Rev	Document Number		
A	533-6823-01	Rev	A
Date:	Friday, January 17, 2014	Sheet	3 of 4

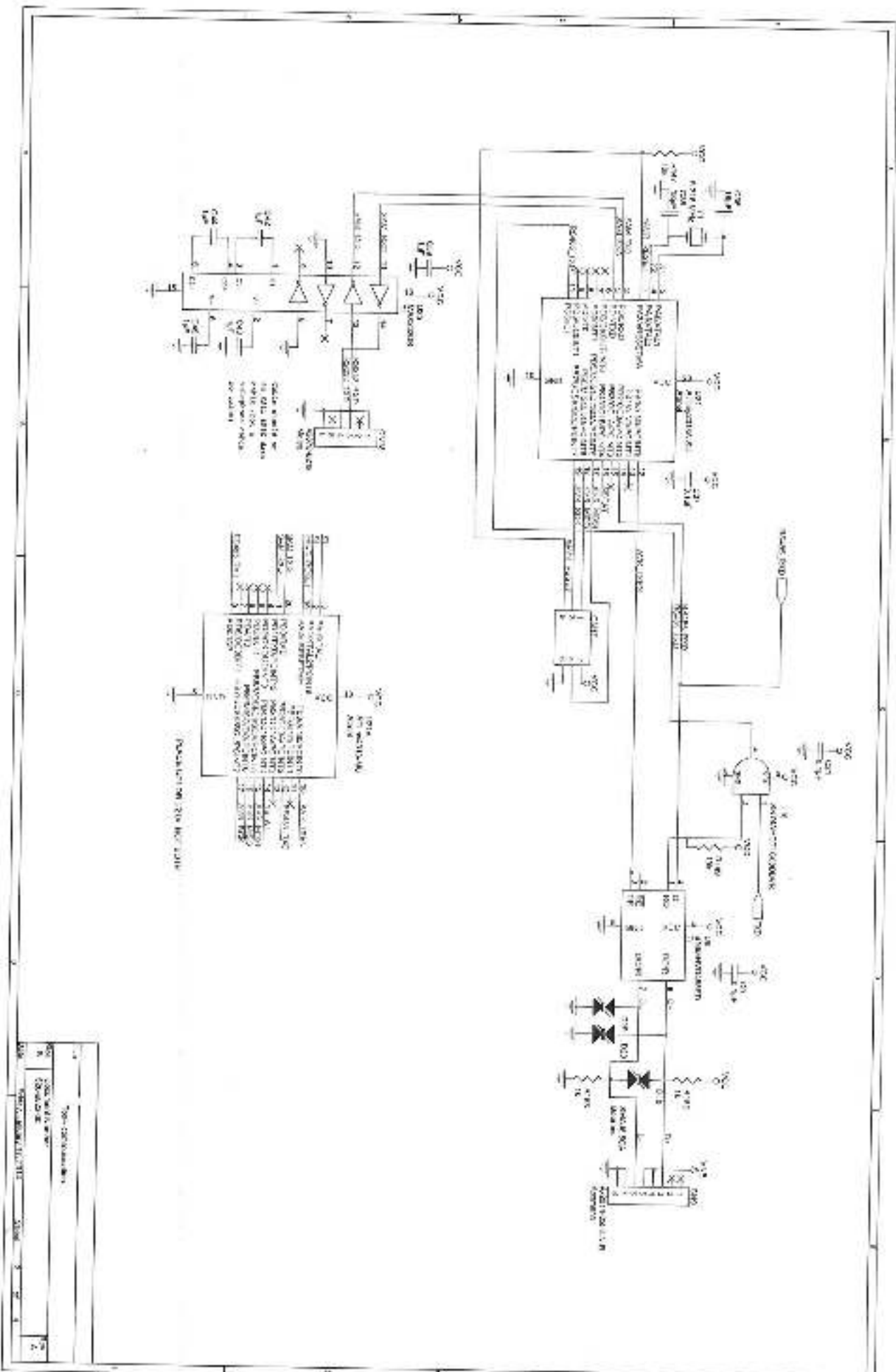

NO.	780-1000000000
REV.	1
DATE	10/10/2000
BY	10/10/2000
CHKD	10/10/2000
APP'D	10/10/2000
REV.	1
DATE	10/10/2000
BY	10/10/2000
CHKD	10/10/2000
APP'D	10/10/2000

ADD HEATSINK FOR Q29
ADD HEATSINK FOR D36

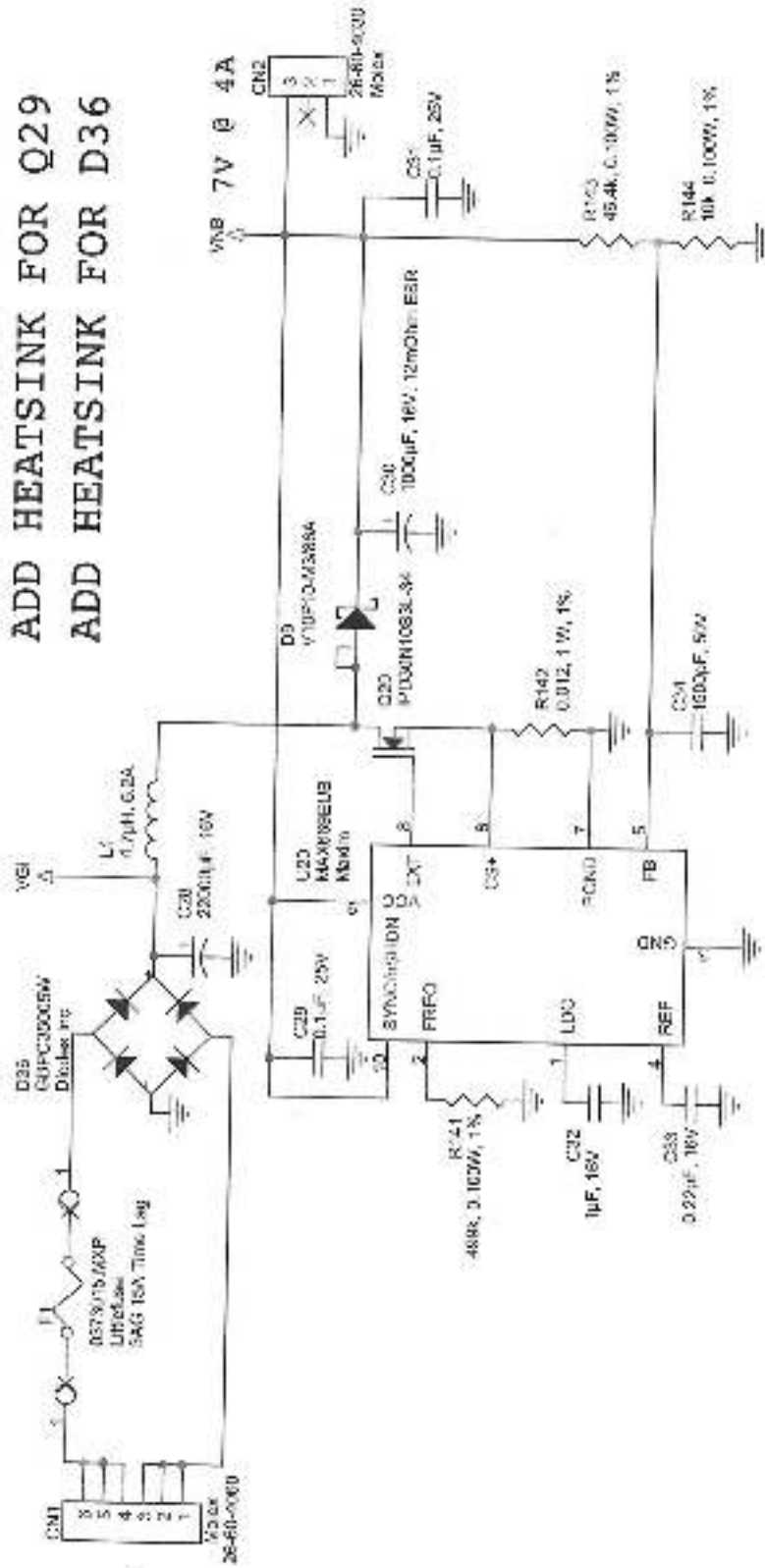

5.7 VAC NOM.

REF: REF
 DIM: DIM
 MOUNTING HOLES: MOUNTING HOLES

Title		Verobus Power Supply
Size	Drawn/Checked	Row
A	CSD 5821-00	C
Date	Wednesday, October 09, 2013	Sheet 1 of 1

Cabinet Universal Voltage Jumper Plugs (for use with Universal AC Cable, 036-5530-00 ONLY)

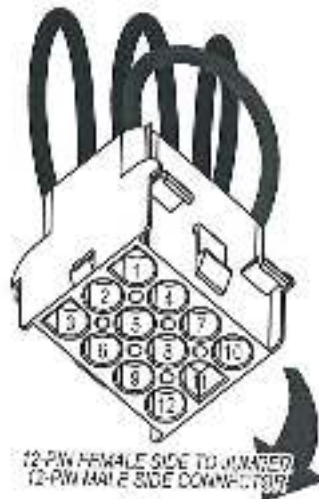

JUMPER PLUG ▼
(SPI PART #036-5530-101)
110+VAC
N. AMERICA
LINE VOLTAGE

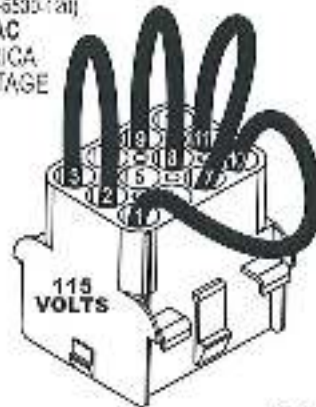

9-PIN MALE SIDE TO TRANSFORMER
9-PIN FEMALE SIDE DOWN

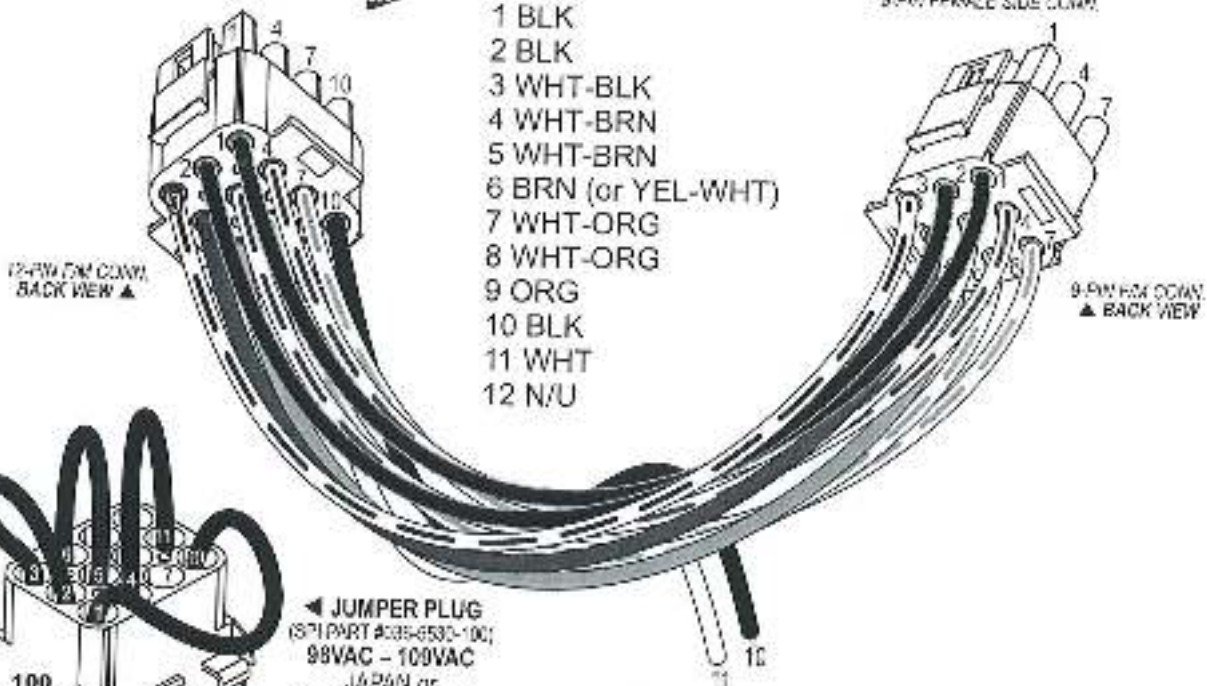

Black & White wires from the POWER BOX, cabinet bottom & 12-Pin Conn., Pins 10 & 11.

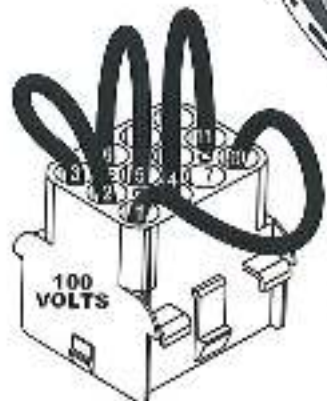

JUMPER PLUG ▼
(SPI PART #036-5530-100)
98VAC - 100VAC
JAPAN or
N. AMERICA LOW
LINE VOLTAGE

JUMPER PLUG ▼
(SPI PART #036-5530-206)
200VAC - 211VAC
EUROPE and
MID. EAST LOW
LINE VOLTAGE

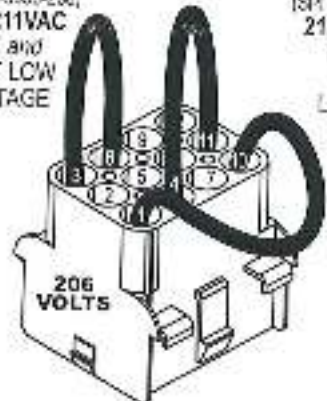

JUMPER PLUG ▼
(SPI PART #036-5530-223)
212VAC - 224VAC
EUROPE and
MID. EAST
LINE VOLTAGE

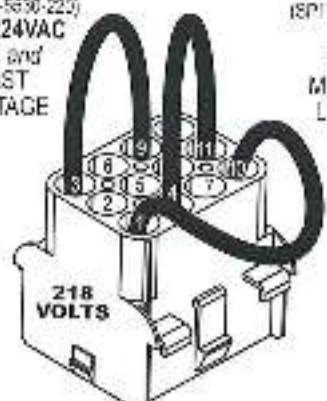

JUMPER PLUG ▼
(SPI PART #036-5530-292)
225+VAC
EUROPE and
MID. EAST HIGH
LINE VOLTAGE

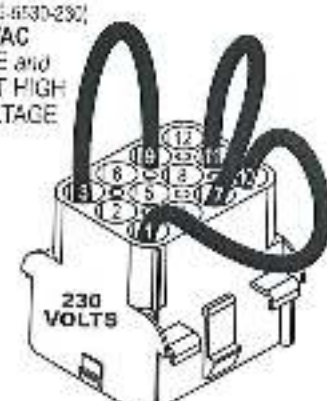

Cabinet Wiring

Cabinet and Coin Door Wiring

Technicians Notes

STERN® PINBALL, INC. LIMITED WARRANTY

Stern® Pinball, Inc., ("seller") warrants only to the initial purchaser of its products that the items listed below are free from defects in material and workmanship under normal use and service for the *warranty period specified*:

Printed Circuit Boards PCBs (game logic):	2 months
Dot Matrix Display PCB:	9 months

No other parts of seller's product are warranted. Warranty periods are effective from the initial date of shipment from seller to its authorized distributors.

Seller's sole liability shall be, at its option, to repair or replace products which are returned to seller during the warranty periods specified, provided:

1. Seller is notified promptly upon discovery by purchaser that stated products are defective.
2. Such products are properly packaged and then returned (freight prepaid, to seller's plant).

This warranty does not apply to any parts damaged during shipment and/or due to improper handling, or due to improper installation or usage, or alteration. In no event shall the seller be liable for any anticipated profits, loss of profits, loss of use, accidental or consequential damages or any other losses incurred by the customer in connection with the purchase of a Stern® Pinball, Inc. product.

WARRANTY DISCLAIMER

Except as specifically provided in a written contract between seller and purchaser, there are no other warranties, express or implied, including any implied warranties of merchantability or fitness for a particular purpose.

CAUTIONS, WARNINGS & NOTICES

For safety and reliability, substitute parts and equipment modifications are not recommended (and may void any warranties). Use of non-Stern® Pinball Inc. parts or modifications of game circuitry, may adversely affect game play, or may cause injuries. Transport pinball games with hinged backbox in the down position only! Always take great care when servicing any game. Always read the service manual before replacing or servicing components. **SUBSTITUTIONS OF PARTS OR EQUIPMENT MODIFICATIONS** may void FCC Type acceptance.



Always disconnect the line voltage before servicing. Some parts may still hold current when unplugged.

WARNING

This equipment generates, uses, and can radiate radio frequency energy, and if not installed and used in accordance with the instructions manual, may cause interference to radio communications. It has been tested and found to comply with the limits for a class A computing device pursuant to SUBPART J OF PART 15 OF FCC RULES, which are designed to provide reasonable protection against such interference when operated in a commercial environment. Operation of this equipment in a residential area is likely to cause interference in which case the user at his own expense will be required to take whatever measures may be required to correct the interference.

RF INTERFERENCE NOTICE: Cable harness placements and ground strap routing on this game have been designed to keep RF radiation and conduction within levels accepted by the FCC rules. To maintain those levels, reposition harnesses and reconnect ground straps to their original placements, if they become disconnected during maintenance.



- (a) "The appliance has to be placed in a horizontal position."
- (b) "This appliance is not to be cleaned by a Water Jet."



603335-7.12.1 (I) "Do not locate this appliance in an area where a Water Jet is used." (II) "Do not clean this appliance with a Water Jet." 603335-7.12.5 (b) If the supply cord is damaged, it must be replaced by the manufacturer, its service agent or similarly qualified persons in order to avoid a hazard.

IEC 60825-1 2ND EDITION AND WAS ISSUED IN 2007

NOTICES

THIS DOCUMENT AND THE DATA DISCLOSED HEREIN OR HEREWITH IS NOT TO BE REPRODUCED (EXCEPT WHERE NOTED), USED OR OTHERWISE DISCLOSED IN WHOLE OR IN PART TO ANYONE WITHOUT WRITTEN CONSENT OF STERN® PINBALL, INC. **WARNING:** PRODUCTS IN THIS MANUAL, THE COMPANY NAME AND DEVICES AND THE DESIGN OF THE MANUAL ITSELF ARE PROTECTED BY FEDERAL PATENTS (AND PATENTS PENDING) DESIGN REGISTRATIONS, TRADEMARKS AND COPYRIGHTS. ACTION WILL BE TAKEN IN THE EVENT OF INFRINGEMENT OR IMITATION. THE RIGHT IS RESERVED TO CHANGE SPECIFICATIONS WITHOUT PRIOR NOTICE.

© 2008 Manufactured by Stern® Pinball, Inc. Stern® Pinball, Inc. is a registered trademark of Stern® Pinball, Inc. All rights reserved. Manufactured in the USA.

UL is a registered trademark of Underwriters Laboratories, Inc. Used by permission.

PCB Schematics (Section 6, Chapter 4/5/6/7) 2008 by
G&S (Creative Electronics & Software, Inc.) who's right.



Patrick Powers
Director of Technical Support



Dorothy Brown
Part Sales Supervisor



Chas Siddiqi
Technical Support Engineer



Angel Hernandez
Shipping Clerk



SERVICE & SUPPORT



Service Manuals

Click here to view our Service Manuals.

- Manuals, Warnings & Notices (linkable from the top page in Service Game Manual)

Care & Maintenance

Click here to view our Care and Maintenance, Troubleshooting and Troubleshooting Tips.

- Current S.A.M. System Games complete Schematic Section
- Archived Drawings for the White Star Board System™

Manuals & Downloads

Click here to view our Manuals & Downloads.

- Offering a range of Game Cards for download
- Country Setting, Pricing Scheme, Dip Switch Setting
- New Default Pricing to US\$ 0.10 for USA Games ONLY
- Custom Pricing Demonstration for S.A.M. System

Game Code Library

Click here to view our Game Code Library.

- Offering S.A.M. System Game Code
- Offering archived White Star Game Code for all Data, East9, Sega™ and STERNS Pinballs (EPROM Programmer required)

Parts

Click here to view our Parts information.

- 2000 - 2009 Complete Pinball Service Game Manuals in PDF format available (includes parts and schematics)

- 2004 - 2005 Select Pinball Service Game Manual (example only): Parts Information & Location (The Pink Pages), Drawings for Major Assemblies & Ramps (The Blue Pages)

- Appendices A - J (updated with each game)

Repair

Click here to view our Repair information.

- NFE Semi-Conductor Cross Reference
- Back Stock Component Database

Warranty

Click here to find out our warranty information.

- 927267 0370

Tips & Tricks

Click here to view our Tips & Tricks information.

- Pinball Machine Team Guide or Packing
- 1st Time Pinball Set-up & Preventative Maintenance
- Pinball Location Maintenance
- How to Update Your Game Code (S.A.M. System)

STERN PINBALL, INC. 2230 Lincoln Avenue - Melrose Park, IL 60160 - Tel: 708.342.3700 - info@ssternpinball.com

Warranty - Privacy Policy

U.S. Customary Inch Ruler



800-KICKERS

5 4 2 5 3 7 7

SPI Part Number
780-50F1-00